

Corner Joining Plates are range of L shaped brackets used with 90 degree mitre cut corner windows and doors. They are used to fix the heads and sills together and to make sure the join is lined as up squarely as possible. They sit inside the head and sill; below the exposed face, and are fixed with counter sunk screws through the face.

The Corner Joining Plates come in 3 sizes:

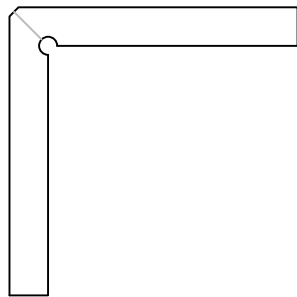

JC1  
5mm

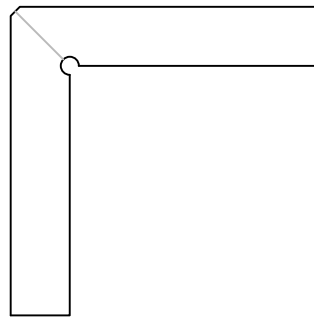

JC2  
8mm

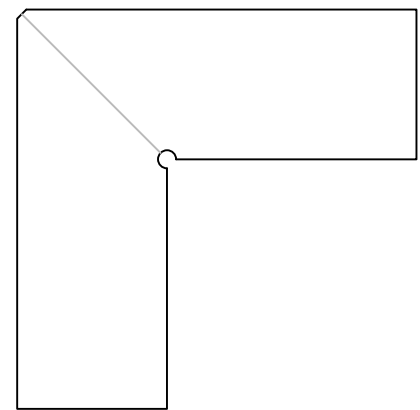

JC3  
20mm

Depending on which window or door you are using, you will require different plates. Refer to the Size and Position guide at the end of this document to determine type(s) and quantities required.

# Corner Joining Plates - Instructions

## Step 1:

Mitre cut head and sill as per production documents.

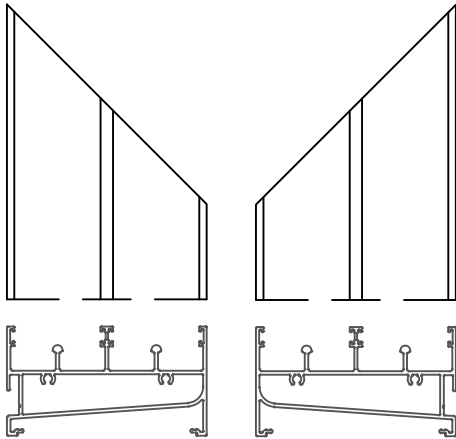

CAD132

Titan Apartment Door

## Step 2:

Drill pilot holes.

Where possible, position corner joining plate on top of head/sill and drill through both. If not, measure and mark head/sill and screw pilot holes separately.

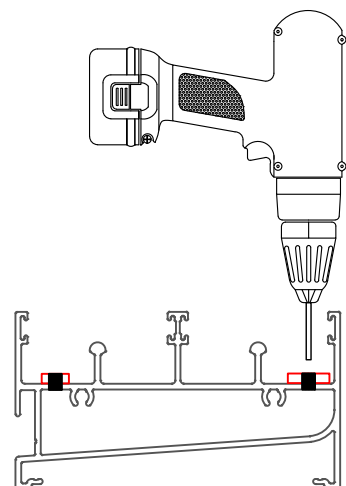
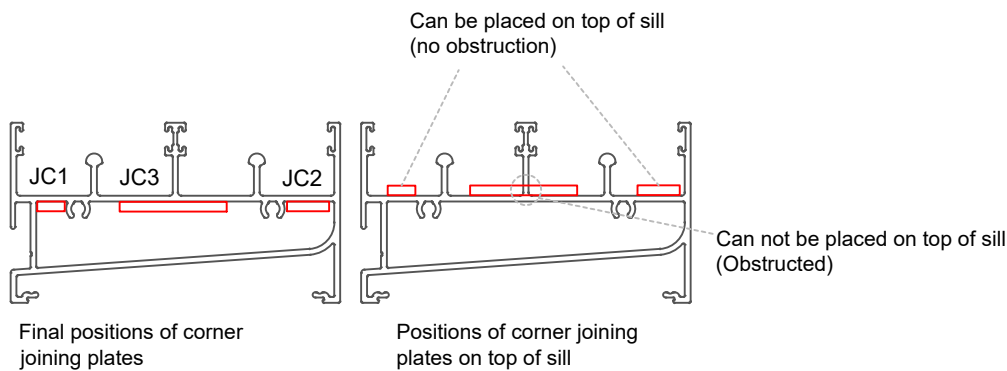

Where possible, position corner joining plates on top face and drill pilot holes through both plate and head/sill, being careful not to drill through sump.

Issue date: June 2021

### IMPORTANT NOTICE

THIS DRAWING AND THE DESIGNS SHOWN ARE THE INTELLECTUAL PROPERTY OF **CONCEPT ARCHITECTURAL SYSTEMS** AND ARE PROTECTED BY COPYRIGHT. THIS DRAWING MAY NOT BE COPIED OR DISTRIBUTED WITHOUT THE WRITTEN CONSENT OF **CONCEPT ARCHITECTURAL SYSTEMS** ©

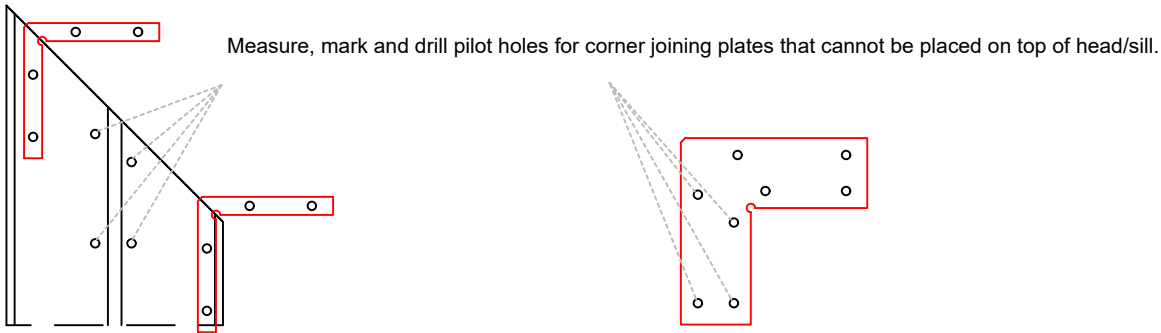

**Step 3:**  
Fix corner joining plates to one side of head/sill.  
Clamp corner joining plates in position and fix through pilot holes.

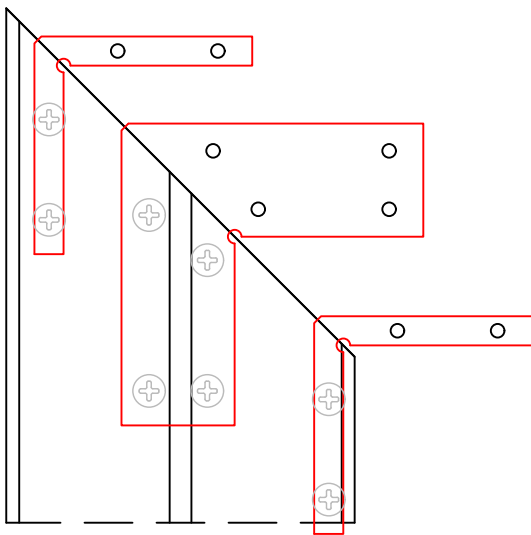

**Step 4:**  
Join head/sill to create corner, fix remaining side of corner joining plates.  
Caulk the internal section of the join, and apply seam sealer to the joining faces to ensure correct drainage and a neat joining seam, and avoid water leakage.

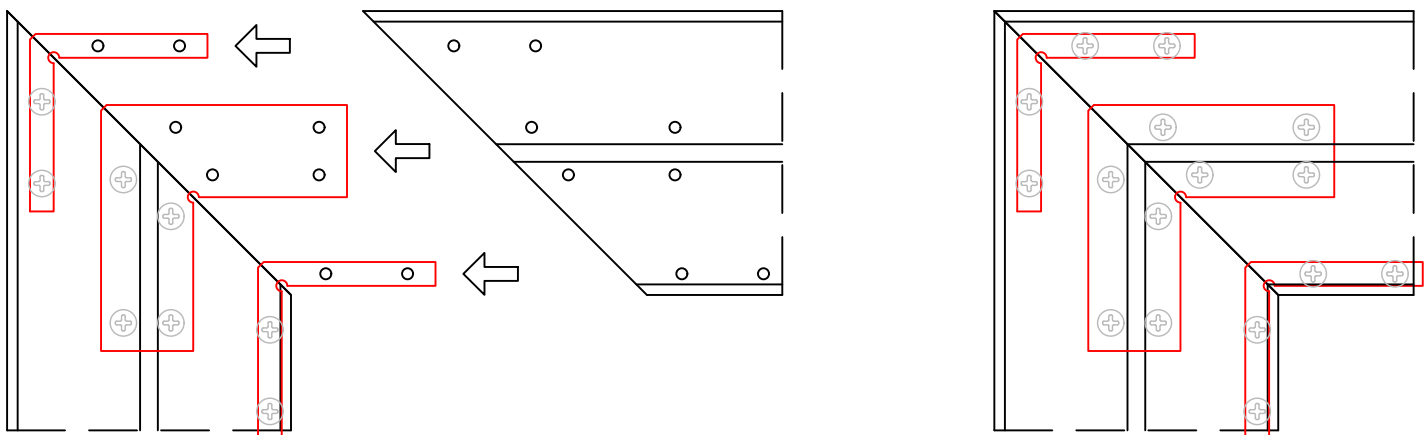

Issue date: June 2021

Use the following guide to determine which corner joint plates to use and where to position them. Different frames may use different plates.

## Centre Glazed Systems

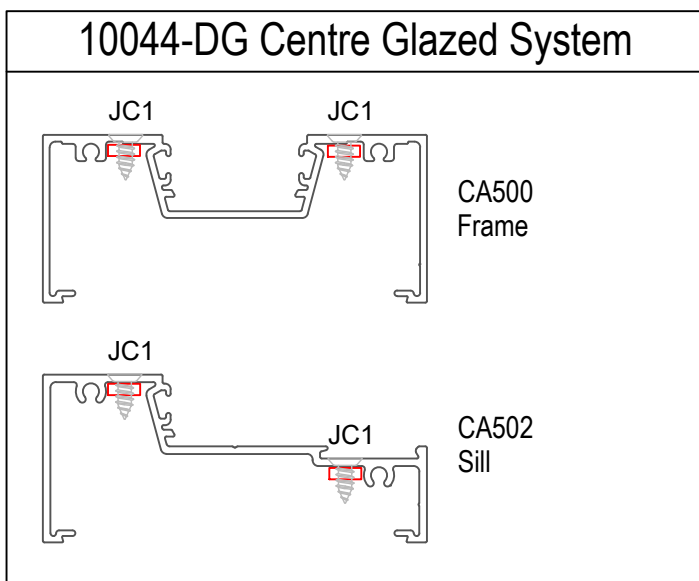
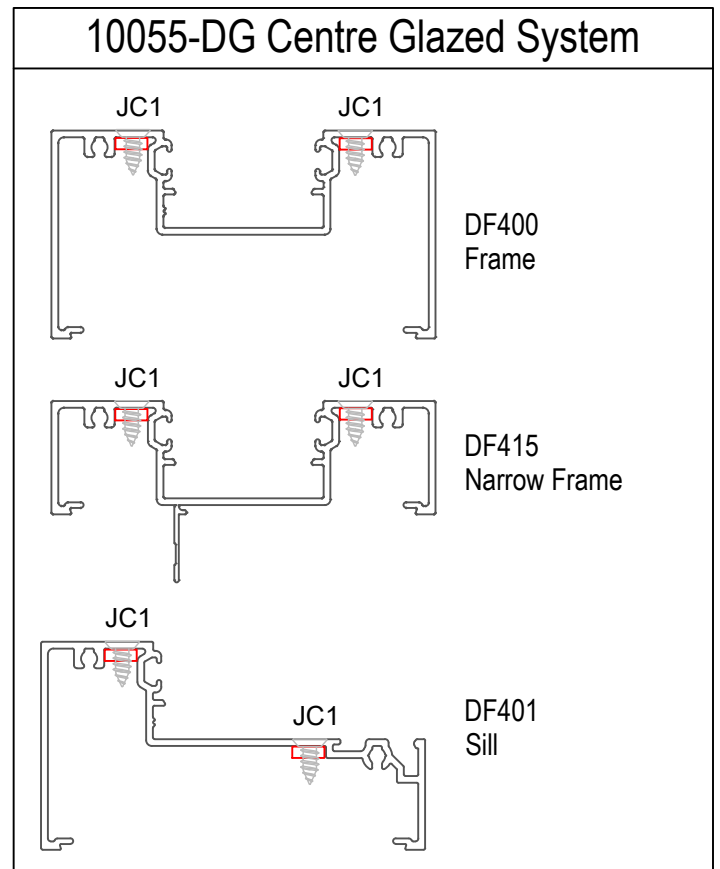
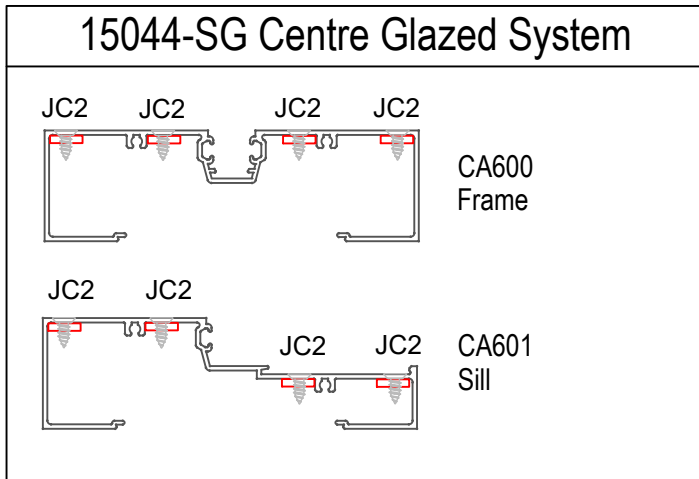
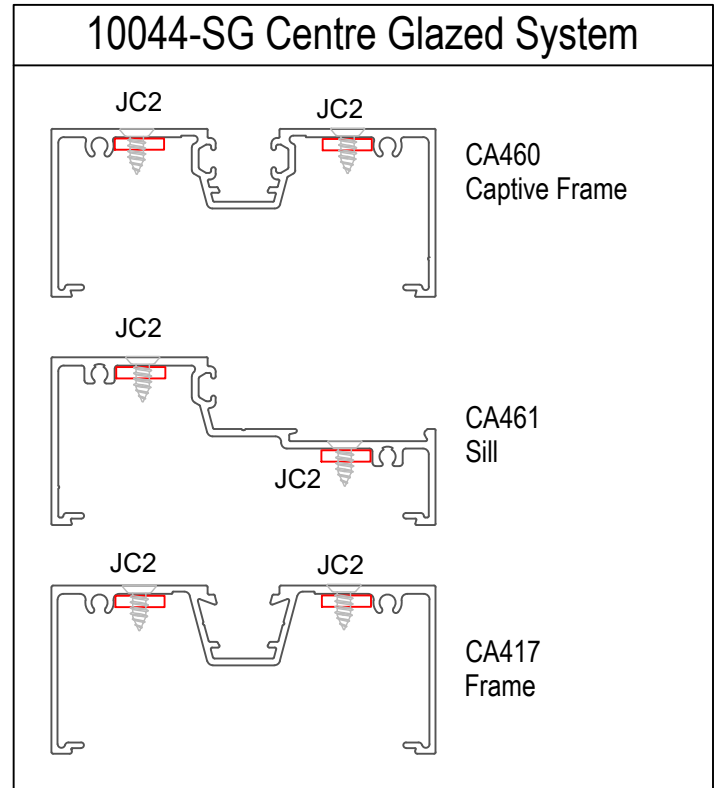
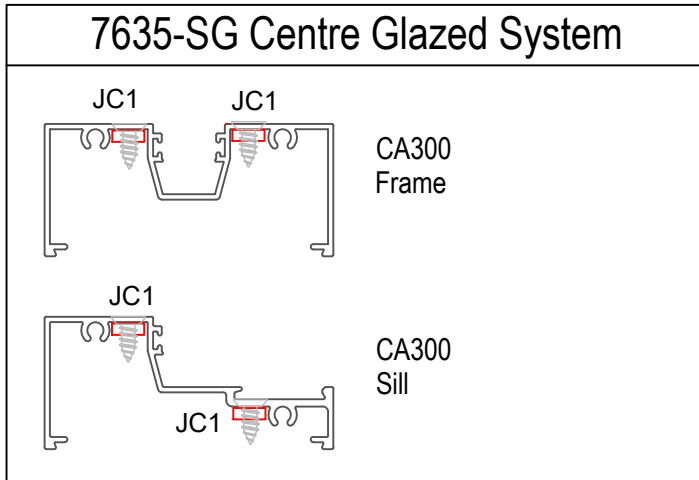

Issue date: June 2021

#### IMPORTANT NOTICE

THIS DRAWING AND THE DESIGNS SHOWN ARE THE INTELLECTUAL PROPERTY OF **CONCEPT ARCHITECTURAL SYSTEMS** AND ARE PROTECTED BY COPYRIGHT. THIS DRAWING MAY NOT BE COPIED OR DISTRIBUTED WITHOUT THE WRITTEN CONSENT OF **CONCEPT ARCHITECTURAL SYSTEMS** ©

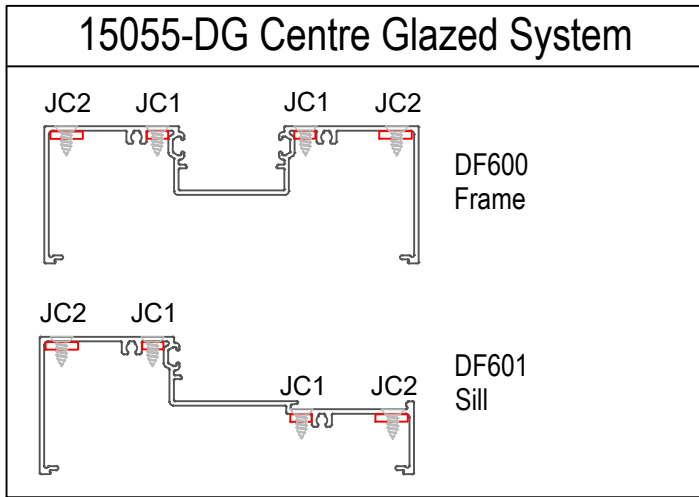

## Front Glazed Systems

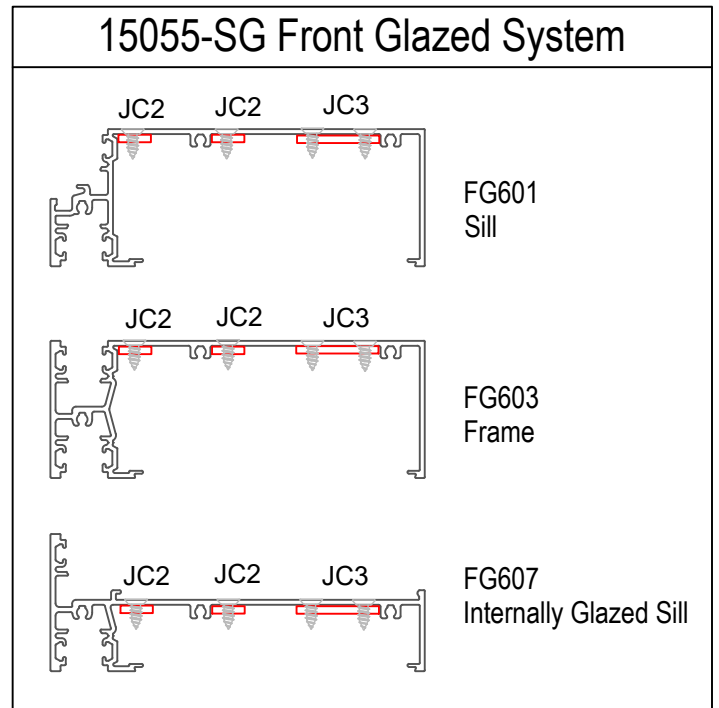
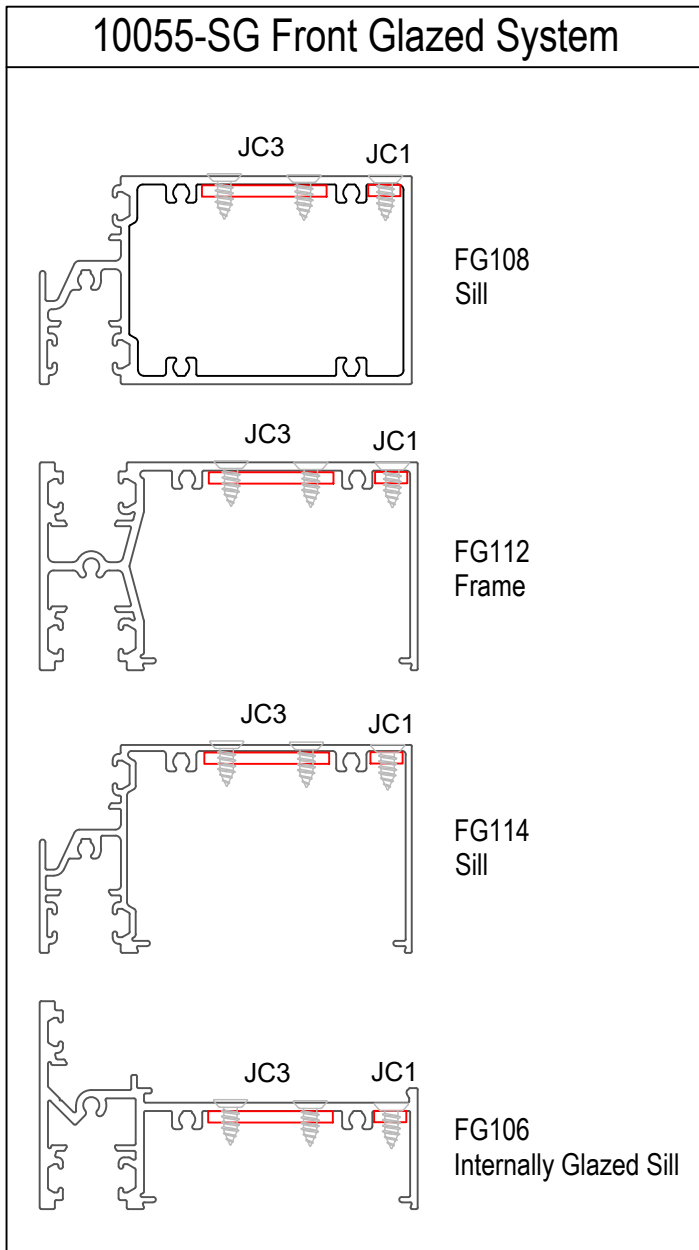

**IMPORTANT NOTICE**

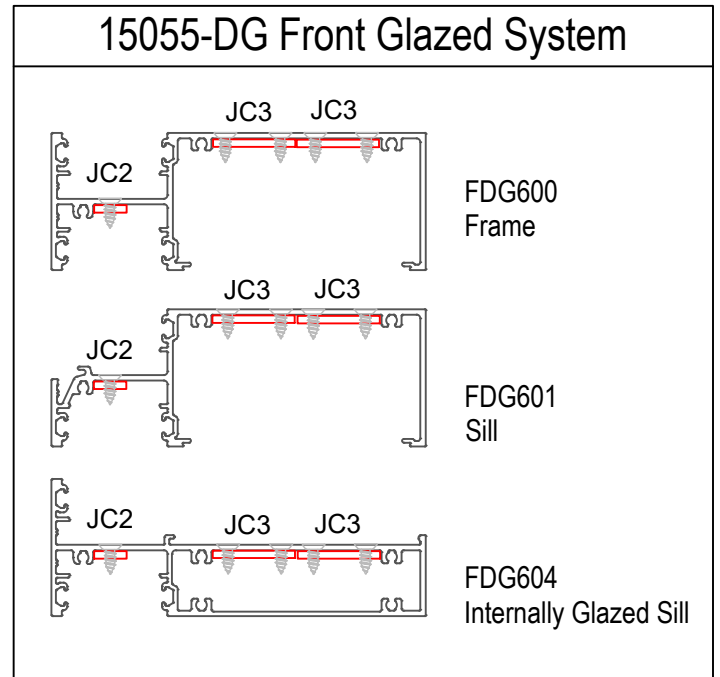
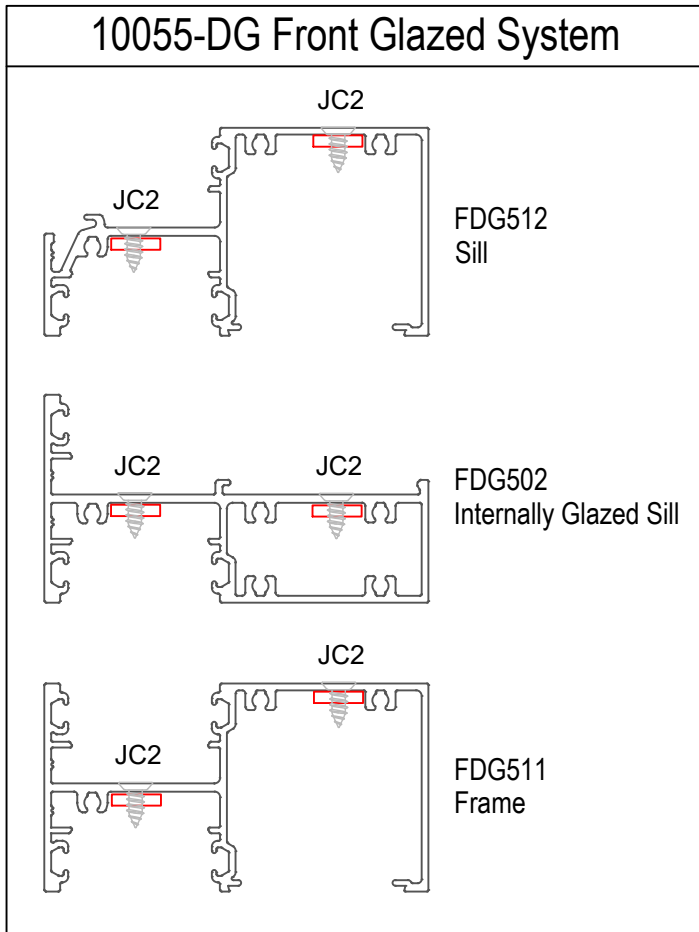

## Flush Glazed Systems

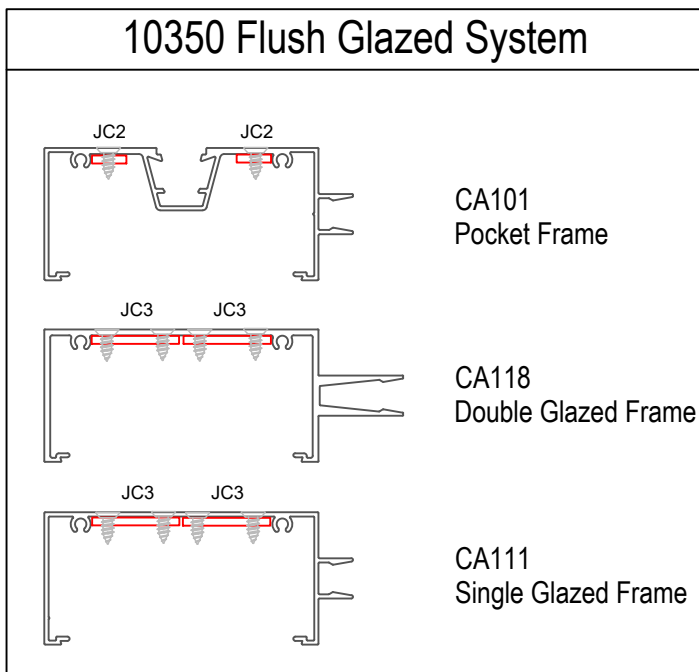

#### IMPORTANT NOTICE

## Apartment Doors

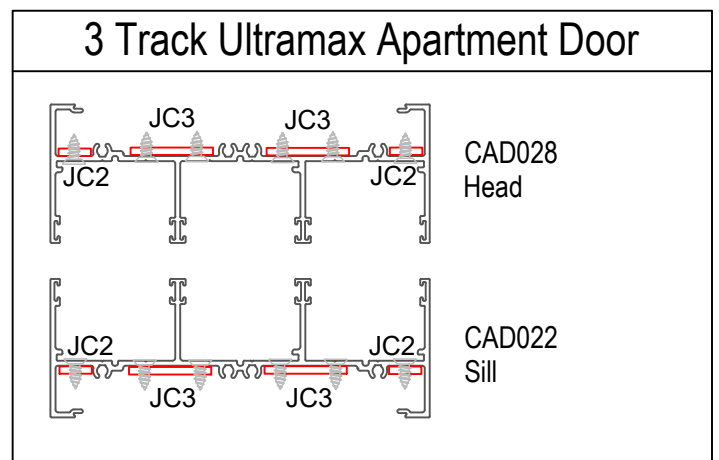
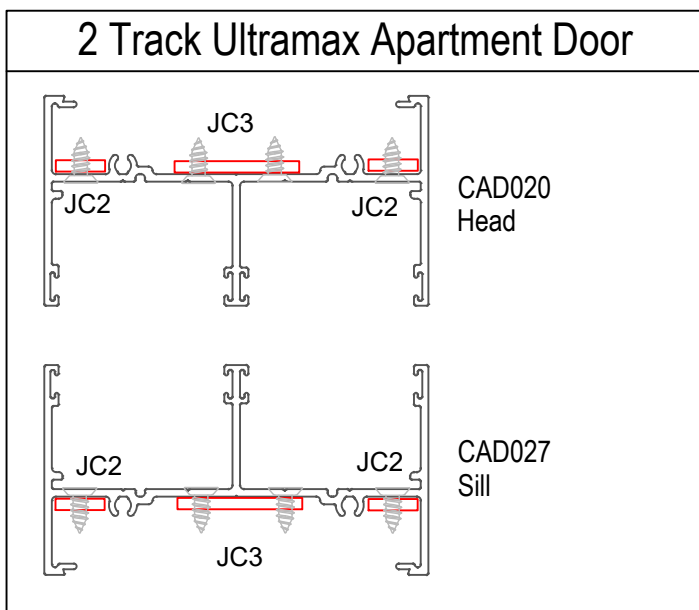
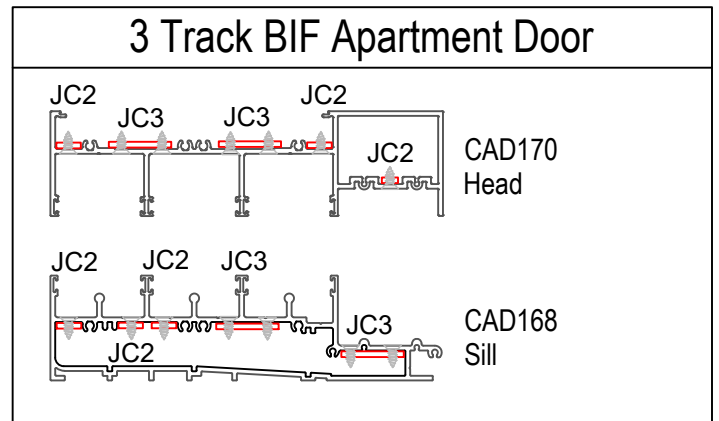
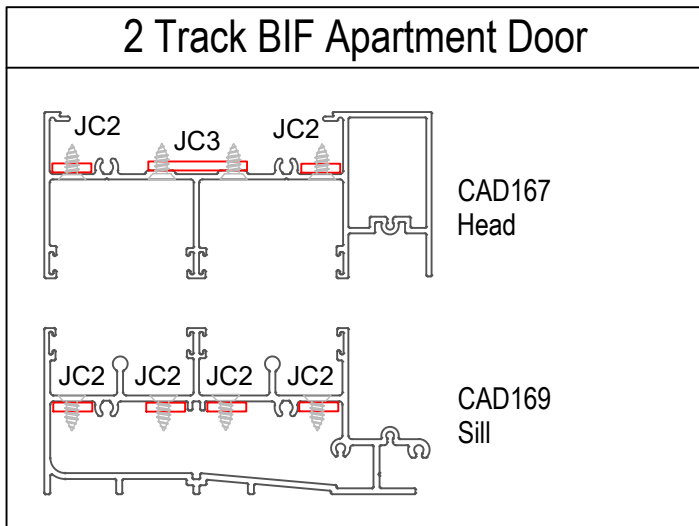
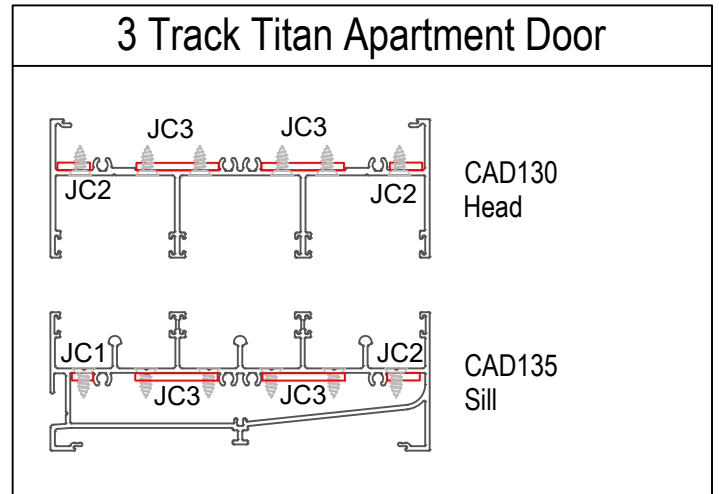
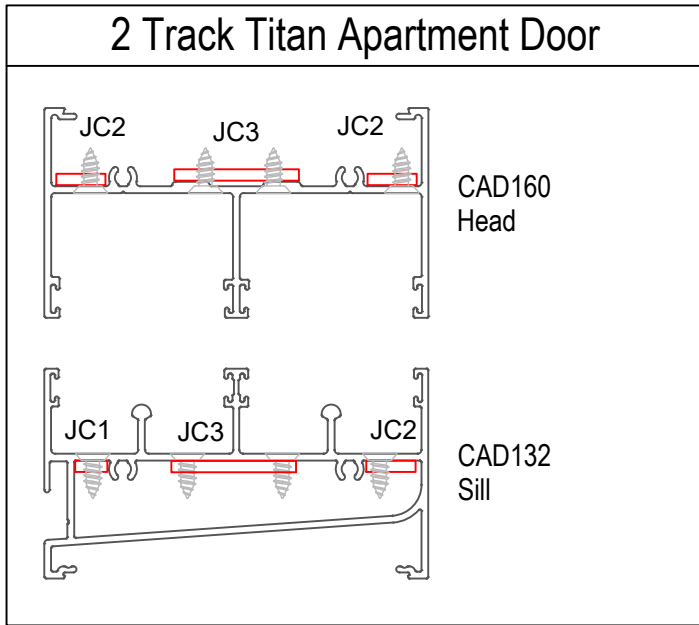

Issue date: June 2021

#### IMPORTANT NOTICE

THIS DRAWING AND THE DESIGNS SHOWN ARE THE INTELLECTUAL PROPERTY OF **CONCEPT ARCHITECTURAL SYSTEMS** AND ARE PROTECTED BY COPYRIGHT. THIS DRAWING MAY NOT BE COPIED OR DISTRIBUTED WITHOUT THE WRITTEN CONSENT OF **CONCEPT ARCHITECTURAL SYSTEMS** ©

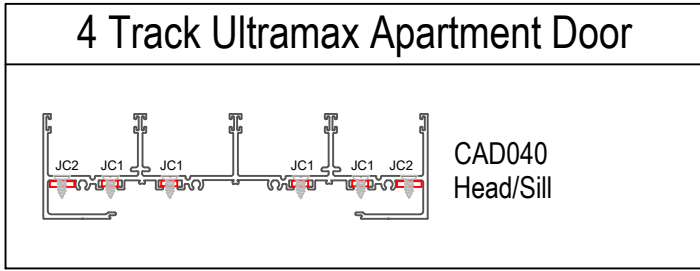

## Sliding Windows

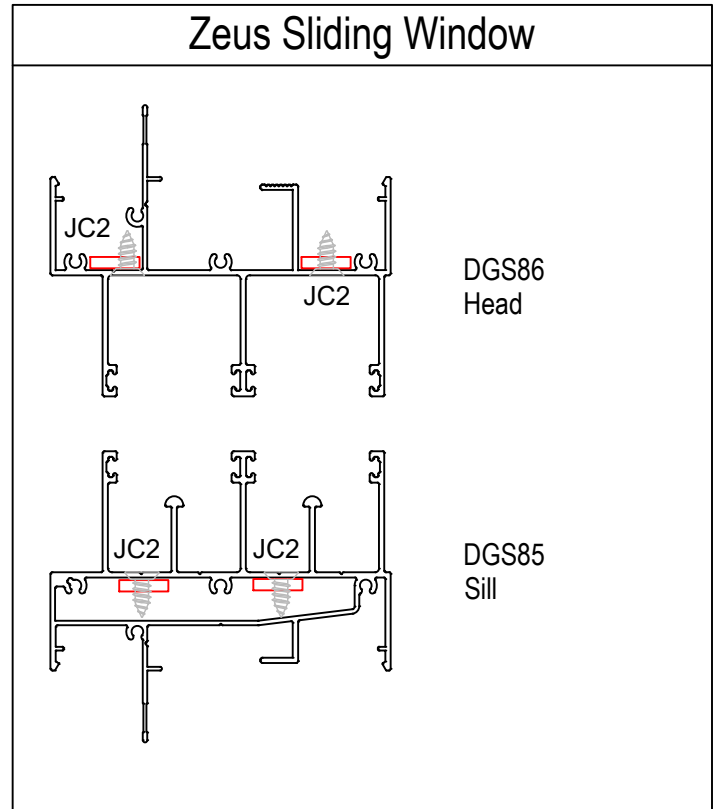
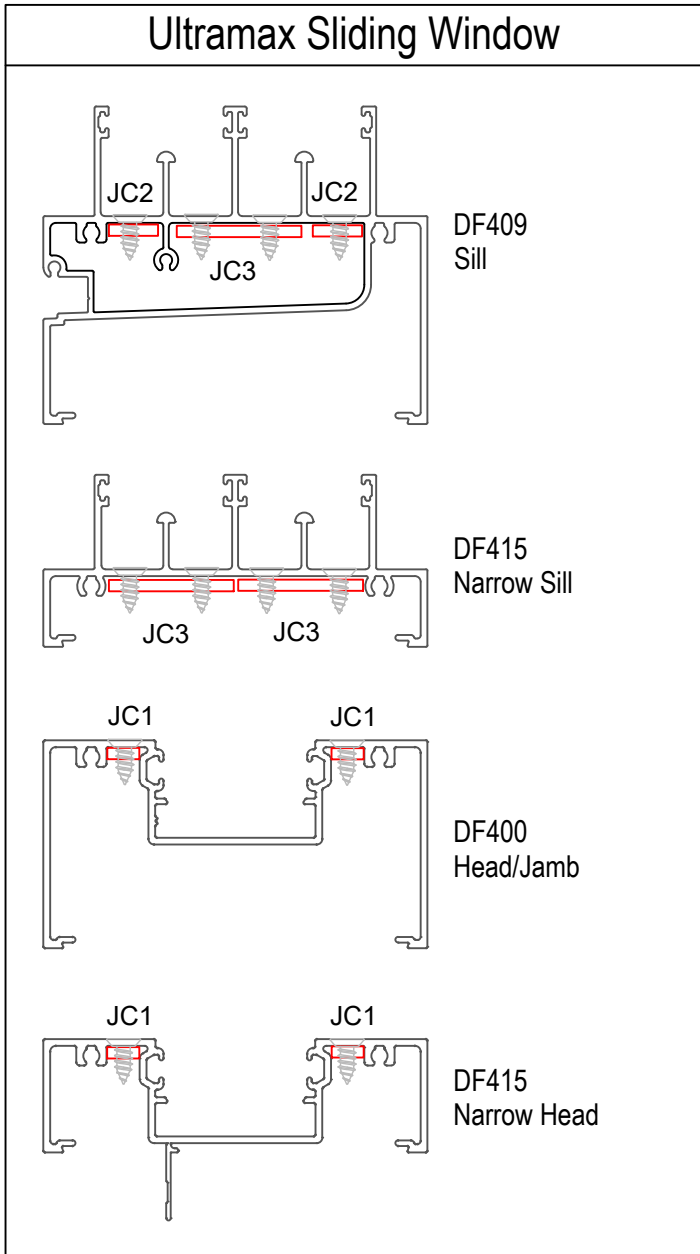



## Domestic Awning Windows (Fixed Only)

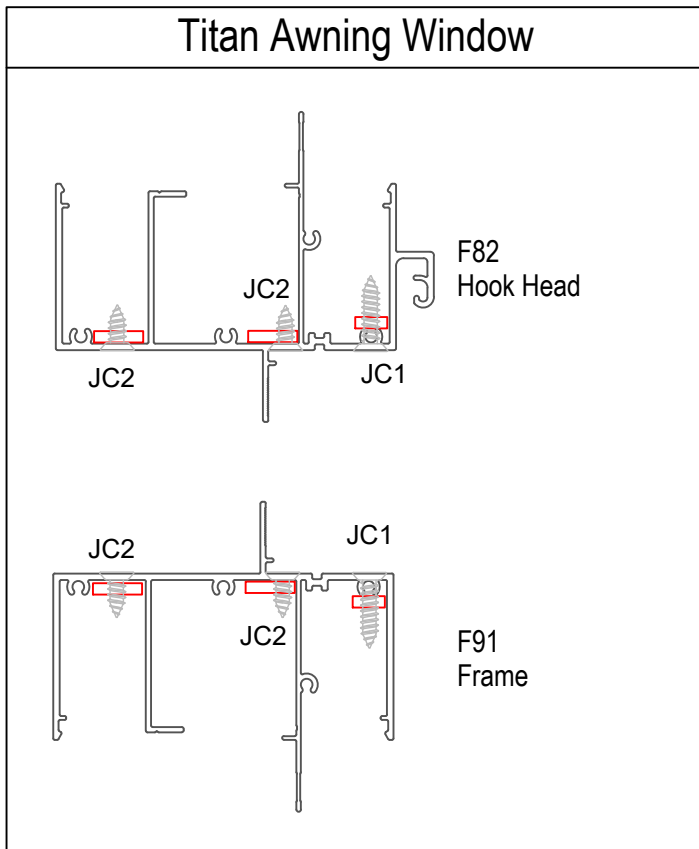
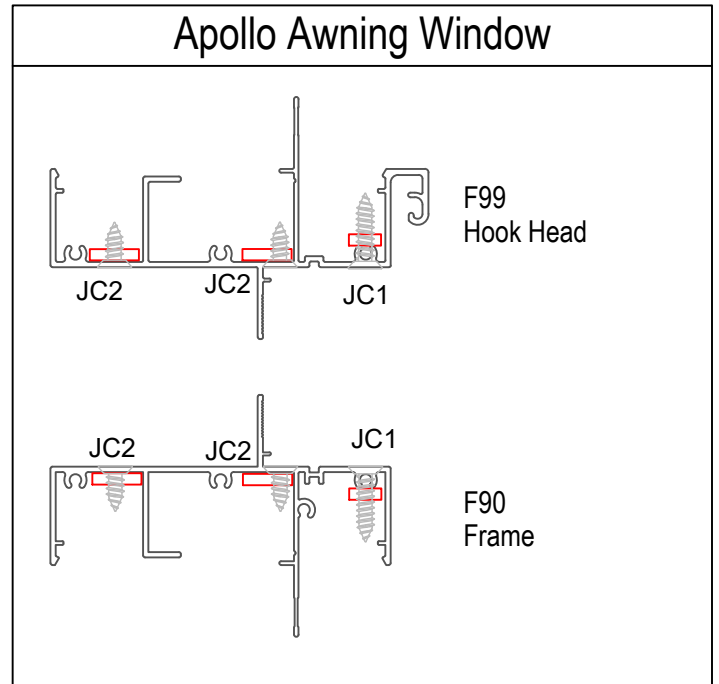
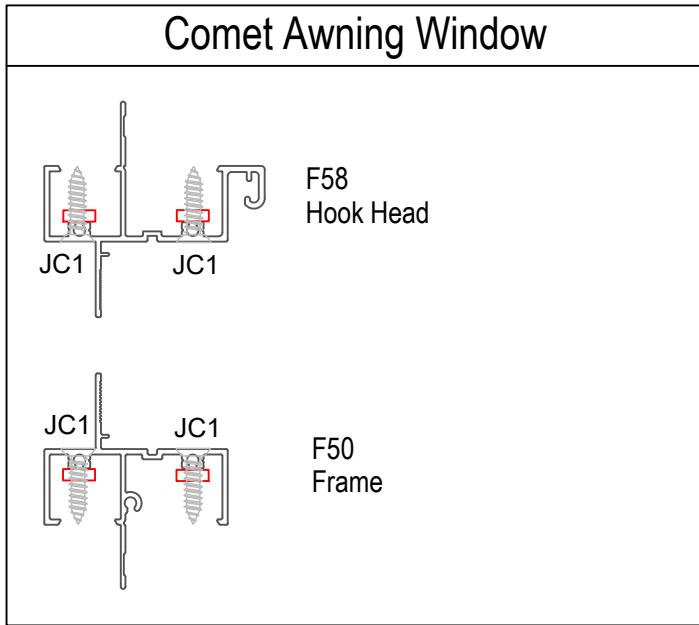

Issue date: June 2021

#### IMPORTANT NOTICE

THIS DRAWING AND THE DESIGNS SHOWN ARE THE INTELLECTUAL PROPERTY OF **CONCEPT ARCHITECTURAL SYSTEMS** AND ARE PROTECTED BY COPYRIGHT. THIS DRAWING MAY NOT BE COPIED OR DISTRIBUTED WITHOUT THE WRITTEN CONSENT OF **CONCEPT ARCHITECTURAL SYSTEMS** ©

## Domestic Sliding Doors

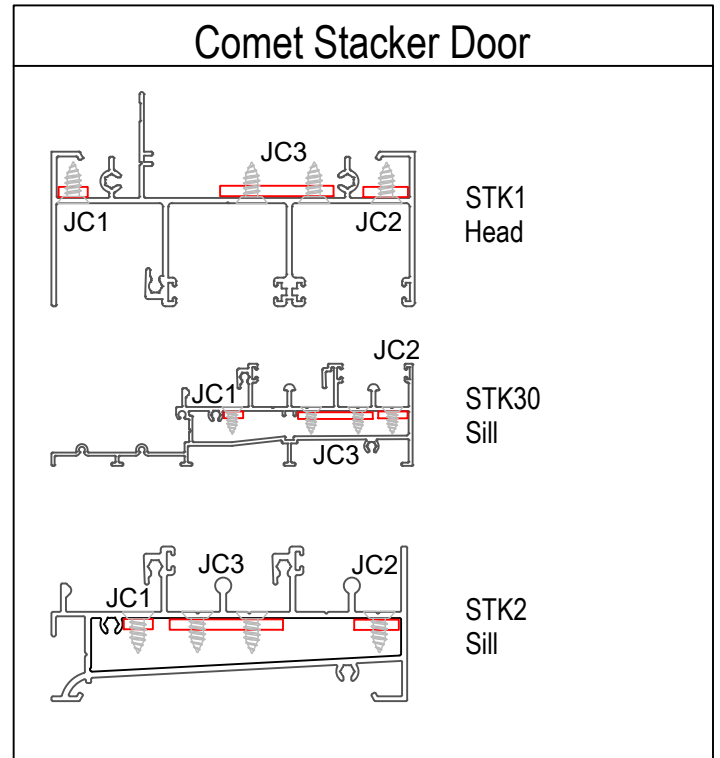
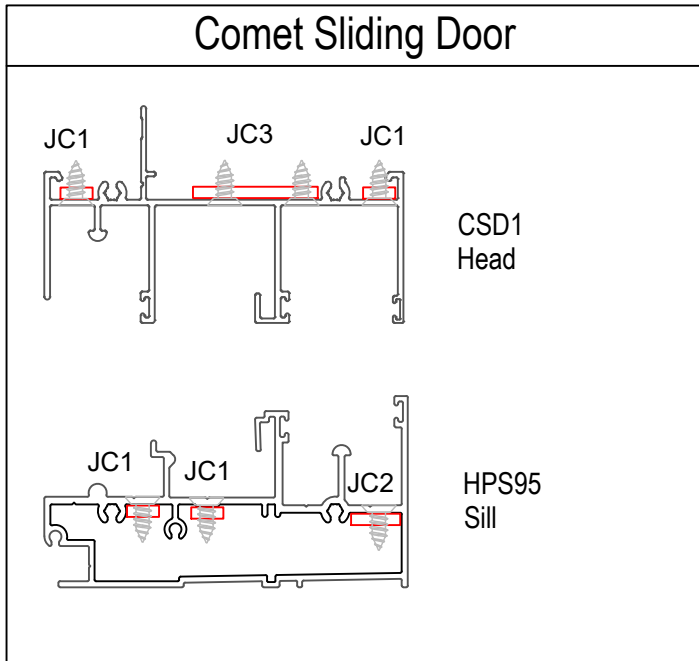

Issue date: June 2021

**IMPORTANT NOTICE**

THIS DRAWING AND THE DESIGNS SHOWN ARE THE INTELLECTUAL PROPERTY OF **CONCEPT ARCHITECTURAL SYSTEMS** AND ARE PROTECTED BY COPYRIGHT. THIS DRAWING MAY NOT BE COPIED OR DISTRIBUTED WITHOUT THE WRITTEN CONSENT OF **CONCEPT ARCHITECTURAL SYSTEMS** ©