

# 2025



## Commercial Window and Door Systems Product Catalogue



# Index

## Center Glazed

6	7635-SG
8	10044-SG
10	10044-DG
12	15044-SG
14	10055-DG
17	10055-DG Inline Sash
19	Ultramax Plus Awning/Casement
23	Ultramax Sliding Window
26	Ultramax Double Hung Window
29	15055-DG

## Front Glazing

31	10055-SG
33	15055-SG
35	10055-DG
37	10055-DG Inline Sash
39	15055-DG Inline Sash
41	15055-DG
44	15055-DG Slab Overlay
46	15055-DG Curtain Wall

## Flush Glazed Frames

48	10350
----	-------

## Office partition

50	64mm Office Partition
----	-----------------------

## Flat Sash

52	Commercial Flat Sash
----	----------------------

## Sub Framing

55	100mm Sub Framing
56	150mm Sub Framing
57	Gutter Sill
57	Miscellaneous Framing Profiles

## Commercial Sliding Doors

58	Titan Apartment Door
60	Ultramax Apartment Door
62	Built-in FlyTrack Apartment Door
63	Flat Jamb Apartment Door
64	Apartment Door Panels
65	Hardware/Accessories
66	Rollers
66	Evolution Sliding Lock Kits
67	Yarra View Edge Lock

## Bi-Fold Door

68	Windsor Bi-Fold Door
70	Windsor Bi-Fold Hardware

## Hinge Door

73	Single Glazed Profiles
74	Double Glazed Profiles
74	Deep Pocket Double Glazed Profiles
75	Sills & Threshold
76	Hardware/Accessories

## Pivot Door

79	Framing Profiles
79	Single Glazed Profiles
80	Double Glazed Profiles
80	Hardware/Accessories

## Top Hung Sliding Door

82	Framing Profiles
82	Single Glazed Profiles
83	Double Glazed profiles
83	Hardware/Accessories

## Additional Systems

84	Beads & Bases
85	Gas Strut Window
87	Louvre's, Privacy Screens and Battens
90	Stealth Rooflight Systems

## Geometrics

93	Powdercoated Angles
94	Angles
95	Channels
96	Flat Bars
98	Square Hollow Sections (SHS)
99	Rectangular Hollow Sections (RHS)
100	Sheets
100	Treadplates

## Miscellaneous

101	Credit Application Form
103	Terms and Conditions

\*\*Please note this catalogue is updated every 6 months and may exclude new profiles or hardware added between this time.

\*\*Front cover photo credits to Clear View Windows VIC

## Our Company

CAS began providing high quality powder coating in 1989. Today, we offer total aluminium solutions, specialises in crafting premium aluminium window and door systems

What sets us apart is our dedication to developing commercial-grade systems tailored for architectural homes. Whether you're building a new home, renovating, or undertaking a large development, CAS windows and doors are designed to deliver unparalleled value and quality to your project.

We collaborate closely with our product development team and local architects to ensure our systems meet the specific needs of Australian designers and excel under Australian building conditions, including in energy efficiency and sustainability. At CAS, we take pride in our client relationships and actively incorporate their feedback to refine and enhance our products. This commitment ensures that our offerings not only meet but exceed industry standards.

Contact us today,

03 9357 2888

[Sales@conceptaluminium.com.au](mailto:Sales@conceptaluminium.com.au)

[www.conceptaluminium.com.au](http://www.conceptaluminium.com.au)



Providing premium  
total aluminium  
solutions.

# Powder Coating

Concept Architectural Systems is committed to providing customers with exceptional powder coating services.

As an accredited applicator with both Dulux and Interpon, we offer an extensive range of coatings and colours that can be tailored to each customer's needs.

Our specialised seven stages pre-treatment facility complies with the requirements of AS3715. This ensures that our products meet stringent performance and durability standards.

With two automatic horizontal paint lines and the latest state of the art equipment, you can rest assured that your job will be completed on time and to the highest quality.

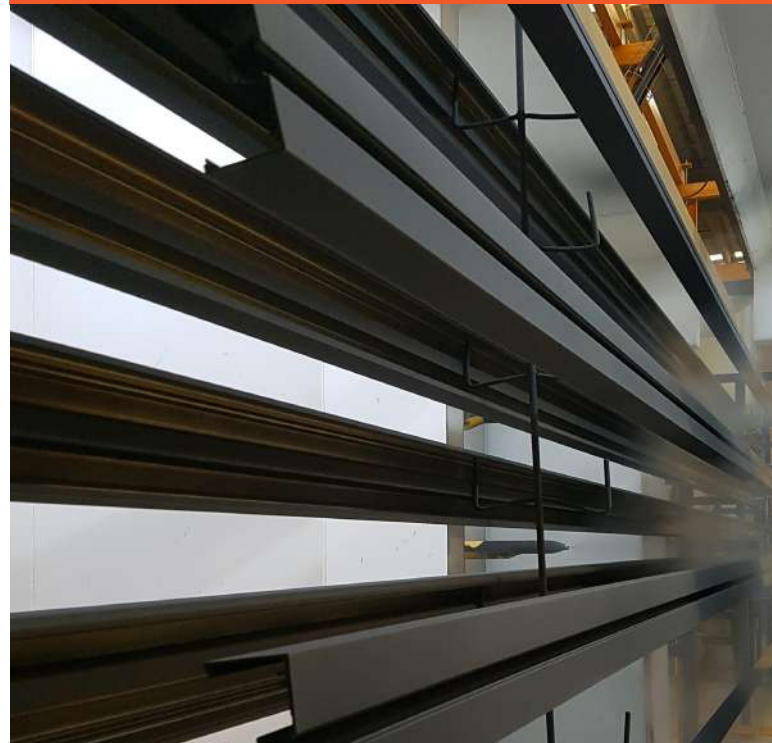



## Tooling for Success

Concept Architectural Systems recognises the importance of tooling as an integral part of the manufacturing process. All tooling required for the manufacture of Concept Architectural Systems' products is designed and built to meet the specific requirements of each fabricator.

We perform a detailed needs analysis to determine the necessary machining functions required to manufacture the product ranges you wish to supply.

Our staff will visit your premises to ensure the tooling we supply suits your factory's layout and existing set up. We take into consideration things such as three phase power availability, pneumatic air capacity and hydraulic drives.

In collaboration with Alumach Aluminium Fabrication Equipment and FOM Industries, we have developed the following three standard tooling packages:

In collaboration with Alumach Aluminium Fabrication Equipment and FOM Industries, we have developed the following three standard tooling packages.

These packages include either a CNC Machining Center or a copy router and end milling machine, a double mitre saw, and a set of workbenches.

These packages are ideal for new fabricators getting started or for existing fabricators looking to upgrade their equipment.

### CAS tooling packages:

- Silver
- Gold
- Platinum

# 7635-SG Center Glazed



The 7635-SG Single Glazed Center Glazed system is ideal for internal partitioning; with the ability to create combinations including Hinged Aluminium or Timber doors as well as awning windows. 7635-SG Center Glazed Framing System integrates with the AluCOMM Hinge Door (pg. 72) and the Flat Sash (pg. 52).

---

## FEATURES

---

- Low profile frame size offers high versatility.
- Captive Wedge system available for 6-6.38mm glazing to ensure easy onsite glazing.
- Combinations with Hinge Doors and Awning sashes.
- 3 Way 90° Corner coupler offers a range of layouts for partitioning.
- Sub Framing available (Subsill & Sub Head).

### FRAME DIMENSIONS

76mm x 35mm

### SINGLE GLAZED

4mm - 6.38mm



# 7635-SG Center Glazed Profiles



**76mm Frame**  
CA300  
Length: 6500



**76mm Sill**  
CA301  
Length: 6500



**Sill Bead**  
CA302  
Length: 6500



**70mm Adapter**  
CA303  
Length: 6500



**70mm Flat Filler**  
CA304  
Length: 6500



**Pocket Filler**  
CA305  
Length: 6500



**45mm Door Stop**  
CA306  
Length: 6500



**Sash Stop**  
CA307  
Length: 6500

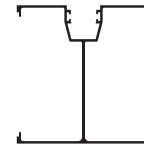

**76mm Corner Post**  
CA308  
Length: 6500



**Slotted SubSill**  
CA309  
Length: 6500  
Subsill Setback: 88mm  
Frame Setback: 82mm



**35mm Door Stop**  
CA310  
Length: 6500



**Sub Head**  
CA311  
Length: 6500

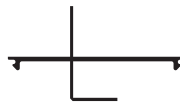

**Reveal Adapter**  
CA313  
Length: 6500



**Door Sill / Threshold**  
CA314  
Length: 6500



**Sill Support**  
Suit CA314  
FB123  
Length: 4000

## Hardware/Accessories



**Captive Wedge**  
6mm  
PX0041



**Glazing Wedge**  
6mm  
PF0774-3



**Co-Ex Sill Baffle**  
PX0040



**Weephole cover**  
WHC1239

# 10044-SG Centre Glazed



## SINGLE GLAZED

4mm - 6.38mm

## FRAME DIMENSIONS

101.6mm x 44.4mm

10044-SG Single Glazed Center Glazed system is one of the most common systems for shopfronts and factory's. It is also widely used in residential applications with a range of installation options and integrates with other systems in the AluCOMM range it is sure to suit any application. 10044-SG Centre Glazed integrates with the following systems: AluCOMM Hinge Door Panels (pg. 72), 100mm Sub Framing (pg. 55), Flat Sash (pg. 52), 2 Track Apartment Doors (pg. 61) and Windsor Bi-Fold (pg. 68).

## PERFORMANCE

### WERS

#### U-Value

4.3-6.1

#### SHGC

0.52-0.72

#### TVW

0.36-0.76

### N3 Non Exposed

#### Serviceability

Up to  
1000 Pa

#### Ultimate Pressure

Up to  
4500 Pa

#### Water Penetration

Up to  
450 Pa

### Acoustic Ratings

#### RW (Fixed)

24-33

#### RW (Awning)

31-38

#### RW (Hinge Door)

27-35

## FEATURES

- Captive Wedge system available, this allows internal glazing at height.
- Combinations with Hinge Doors and Awning sashes.
- Uses an overlapping 60mm Flat Sash with a Hook Head system.
- 3 Way 90° Corner coupler allows corner combinations and 3 way T corners.
- Install using sub framing (Subsill & Sub Head).
- A large range of sub framing options available.
- All subsills have injection molded end caps available to assist with subsill end sealing.



# 10044-SG Centre Glazed Profiles



**Frame Standard Wedge**  
CA417  
Length: 6500



**Frame Captive Wedge**  
CA460  
Length: 6500



**Sill**  
CA461  
Length: 6500



**Bead**  
CA462  
Length: 6500



**Adapter**  
CA463  
Length: 6500



**90mm Flat Filler**  
CA102  
Length: 6500



**45mm Door Stop**  
CA458  
Length: 6500



**45mm Door Stop**  
CA407  
Length: 6500



**40mm Door Stop**  
CA455  
Length: 6500



**35mm Door Stop**  
CA408  
Length: 6500



**Pocket Filler**  
CA409  
Length: 6500

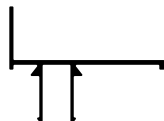

**Sash Stop**  
CA413  
Length: 6500



**Corner Post**  
CA414  
Length: 6500



**Split Mullion**  
CA464  
Length: 6500



**H/D Split Mullion**  
CA416  
Length: 6500



**Plain Frame**  
CA437  
Length: 6500



**Narrow Jamb**  
CA424  
Length: 6500



**Split Mullion V Seal**  
PX0075



**Captive Wedge 4mm-6mm**  
PX0005



**Captive Wedge 8mm-10mm**  
PX0026

## Hardware/Accessories



**Glazing Wedge 4mm**  
PF0774-1



**Glazing Wedge 5mm**  
PF0774-2



**Glazing Wedge 6mm**  
PF0774-3



**Glazing Wedge 8mm**  
PF0774-5



**Glazing Wedge 10mm**  
PF0829



**Weephole cover**  
WHC1239

# 10044-DG Centre Glazed



## DOUBLE GLAZED

24mm

## FRAME DIMENSIONS

101.6mm x 44.4mm

10044-SG Double Glazed Center Glazed system is very popular for shopfronts and factories that require the benefits of double glazing. This system suits a 24mm DGU. 10044-DG Centre Glazed integrates with the following systems: AluCOMM Hinge Door Panels (pg. 72), 100mm Sub Framing (pg. 55), Flat Sash (pg. 52), 2 Track Apartment Doors (pg. 61) and Windsor Bi-Fold (pg. 68).

## PERFORMANCE

### WERS Ratings

#### U-Value

2.5-3.4

#### SHGC

0.40-0.63

#### TVW

0.32-0.69

### Acoustic Ratings

#### RW (Fixed)

29-41

#### RW (Awning)

29-36

## FEATURES

- Captive Wedge system available for 24mm glazing, this allows internal glazing at height.
- Combinations with Hinge Doors and Awning sashes.
- Uses an overlapping 60mm Flat Sash with a Hook Head system.
- Install using sub framing (Subsill & Sub Head) Timber reveal options available.
- A large range of sub framing options available.
- All subsills have an injection molded end cap available to assist with subsill end sealing.

# 10044-DG Centre Glazed Profiles



**Frame**  
CA500  
Length: 6500

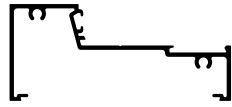

**Sill/Transom**  
CA502  
Length: 6500

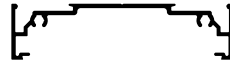

**Double Beaded Sill**  
CA507  
Length: 6500



**Bead**  
CA503  
Length: 6500



**Adapter**  
CA504  
Length: 6500

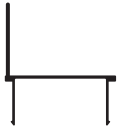

**Sash Stop**  
CA505  
Length: 6500



**Pocket Filler**  
CA501  
Length: 6500



**Door Stop**  
CA506  
Length: 6500

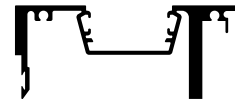

**H/D Split Mullion**  
CA511  
Length: 6500



**90mm Flat Filler**  
CA102  
Length: 6500

## Hardware/Accessories



**Captive Wedge**  
18mm-20mm  
PX0096



**Captive Wedge**  
24mm  
PX0005



**Captive Wedge**  
26mm-28mm  
PX0026



**Split Mullion V Seal**  
PX0075



**Weephole cover**  
WHC1239



**Glazing Wedge**  
18mm DGU  
PF0688-5



**Glazing Wedge**  
20mm DGU  
PF0774-4



**Glazing Wedge**  
24mm DGU  
PF0774-2



**Glazing Wedge**  
26mm DGU  
PF0774-3



**Glazing Wedge**  
28mm DGU  
PF0774-5

# 15044-SG Centre Glazed



The 15044-SG Single Glazed Center Glazed system has been designed for all shopfront applications. It has a captive Wedge option that will suit glazing from 6.38mm up to 10.38mm. 15044-SG Centre Glazed integrates with the following systems: AluCOMM Hinge Door Panels (pg. 72), 150mm Sub Framing (pg. 56), Flat Sash (pg. 52).

## SINGLE GLAZED

4mm - 10.38mm

## FRAME DIMENSIONS

150mm x 44.4mm

## FEATURES

- Captive Wedge system available, this allows internal glazing height.
- Combinations with Hinge Doors and Awning sashes.
- Uses an overlapping 60mm Flat Sash with a Hook Head System.
- Install using a sub framing (Subsill & Sub Head).
- A large range of sub framing options available.
- All subsills have an injections moulded end cap available to assist with subsill end sealing.

# 15044-SG Centre Glazed Profiles



**Frame**  
CA600  
Length: 6500



**Sill**  
CA601  
Length: 6500



**Bead**  
CA602  
Length: 6500



**Adapter**  
CA463  
Length: 6500



**Mullion**  
CA608  
Length: 6500



**Frame Pocket Filler**  
CA409  
Length: 6500



**2 Piece Plant On Door Stop**  
CA459  
Length: 6500



**Door Stop Pocket Filler**  
CA305  
Length: 6500



**Plant On Door Stop**  
CA427  
Length: 6500

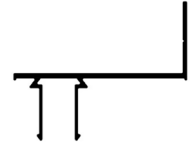

**Sash Stop**  
CA612  
Length: 6500



**90mm Flat Filler**  
CA102  
Length: 6500

## Hardware/Accessories



**Split Mullion V Seal**  
PX0075



**Captive Wedge 4mm-6mm**  
PX0005



**Captive Wedge 8mm-10mm**  
PX0026



**Glazing Wedge 4mm**  
PF0774-1



**Glazing Wedge 5mm**  
PF0774-2



**Glazing Wedge 6mm**  
PF0774-3



**Glazing Wedge 8mm**  
PF0774-5



**Glazing Wedge 10mm**  
PF0829



**Weephole cover**  
WHC1239

# 10055-DG Centre Glazed

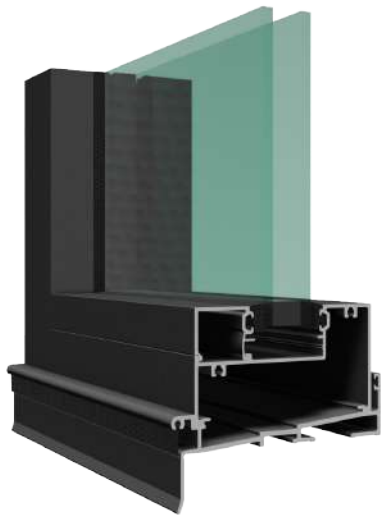

## SINGLE GLAZED

4mm - 10.38mm

## DOUBLE GLAZED

26mm - 32mm

## FRAME DIMENSION

101.6mm x 55mm

The 10055-DG Centre Glazed system is a versatile system that has been designed to meet the ever increasing glass requirements. It is primarily a Double Glazed system but can easily be adapted to Single Glazing reducers. 10055-DG Centre Glazed integrates with the following systems: AluCOMM Hinge Door Panels (pg. 72), 100mm Sub Framing (pg. 55), Flat Sash (pg. 52), 2 Track Apartment Doors (pg. 61), Ultramax Sliding Window (pg. 23), Ultramax Plus Awning/Casement (pg. 19), Windsor Bi-Fold (pg. 68).

## PERFORMANCE

### WERS Ratings

#### U-Value

2.3-6.0

#### SHGC

0.26-0.74

#### TVW

0.25-0.73

### Performance ratings

N5 & C3 Exposed

#### Serviceability

Up to  
1800 Pa

#### Ultimate Pressure

Up to  
3000 Pa

#### Water Penetration

Up to  
200 Pa

## FEATURES

- Captive Wedge system available for both single and double glazing.
- Combinations with Hinge Doors and Awning sashes integrates seamlessly with the Ultramax Sliding Window and Ultramax Sliding Window and Ultramax Apartment Door.
- Uses and overlapping 60mm Flat Sash with a hook head system.
- Install using sub framing (Subsill & Sub Head).
- 90 Corner Coupler allows corner combinations and 3 way T corners.
- A large range of sub framing options available.
- All subsills have an injection moulded end cap available to assist with subsill end sealing .

# 10055-DG Centre Glazed Profiles

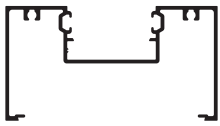

**Frame**  
DF400  
Length: 6500

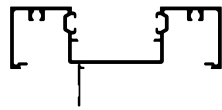

**Low Profile Frame**  
DF414  
Length: 6500

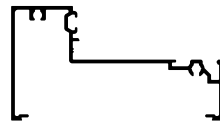

**Sill**  
DF401  
Length: 6500

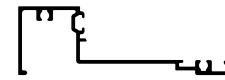

**Low Profile Sill**  
DF417  
Length: 6500



**Sill Bead**  
DF402  
Length: 6500



**Adapter**  
DF403  
Length: 6500

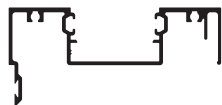

**Split Mullion**  
DF404  
Length: 6500



**Sash Stop  
(Flat Sash)**  
DF406  
Length: 6500



**Door Stop**  
DF405  
Length: 6500



**Pocket Filler**  
DF605  
Length: 6500

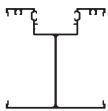

**Corner Post**  
DF407  
Length: 6500



**S/G Pocket Reducer**  
DF606  
Length: 6500



**S/G Sill Reducer**  
DF610  
Length: 6500



**S/G Sill Bead**  
DF408  
Length: 6500

## Hardware/Accessories



**Captive Wedge**  
22mm-26mm  
PX0096



**Captive Wedge**  
28mm  
PX0005



**Captive Wedge**  
30mm-32mm  
PX0026



**Glazing Wedge**  
22mm  
PF0774-1



**Glazing Wedge**  
24mm/30mm  
PF0774-3



**Glazing Wedge**  
26mm  
PX0085



**Glazing Wedge**  
28mm  
PF0774-2



**Glazing Wedge**  
32mm  
PF0774-5



**Split Mullion  
V Seal**  
PX0075



**Weephole cover**  
WHC1239



# 10055-DG Centre Glazed 50mm Pocket

## Section profiles

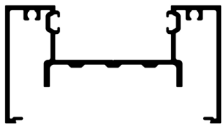

**Frame**  
DF450  
Length: 6500

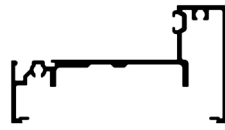

**Sill**  
DF451  
Length: 6500



**Sill Bead**  
DF454  
Length: 6500



**Adapter**  
DF453  
Length: 6500

## Hardware/Accessories



**Captive Wedge**  
34mm-38mm  
PX0096



**Captive Wedge**  
40mm  
PX0005



**Captive Wedge**  
42mm-44mm  
PX0026



**Glazing Wedge**  
34mm  
PF0774-1



**Glazing Wedge**  
36mm/42mm  
PF0774-3



**Glazing Wedge**  
38mm  
PX0085



**Glazing Wedge**  
40mm  
PF0774-2



**Glazing Wedge**  
44mm  
PF0774-5



**Weephole cover**  
WHC1239

10055-DG 50mm Pocket sections have a wide 50mm glazing pocket and can accept IGU's up to 44mm. It couples with all standard 10055-DG sections.

# 10055-DG Inline Sash



The 10055-DG Centre Glazed Inline Sash suite is a brand new system designed to seamlessly integrate with the 10055-DG Centre Glazed framing system. The sash closes flush with the frame, giving the Inline Sash an incredibly clean finish. It includes a dedicated head, transom, and sill to allow for quick and easy installation and superior water performance to the 10055-DG Centre Glazed system. It adds a new level of versatility to the 10055-DG Centre Glazed system and is the perfect addition to your next commercial project.

## FEATURES

- Stunning inline sash profile that closes flush with the frame.
- Integrates seamlessly with the 10055-DG Center Glazed framing system.
- Dedicated framing profiles for ease of installation.
- Combinations with Hinge Doors and Awning sashes.
- A large range of sub framing options available.

## PERFORMANCE

### DOUBLE GLAZED

26mm - 30mm

### FRAME DIMENSION

101.6mm x 55mm

### Acoustic Ratings

RW

32-41

# 10055-DG Inline Sash Profiles

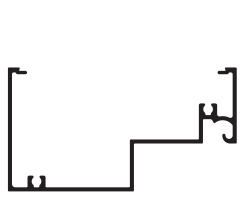

**Inline Sash  
Transom/Head**  
DF411  
Length: 6500

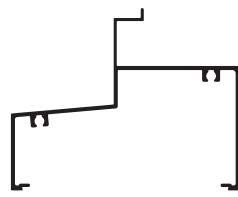

**Inline Sash  
Transom/Sill**  
DF412  
Length: 6500

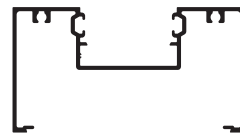

**Frame**  
DF400  
Length: 6500



**Inline Sash Stop**  
DF413  
Length: 6500

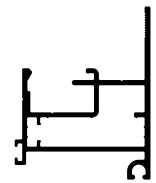

**Inline Sash**  
FDG520  
Length: 6500

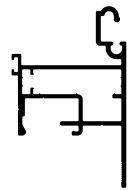

**Inline Hook Sash**  
FDG522  
Length: 6500



**Sash Bead  
Double Glazed**  
CA703  
Length: 6500



**Pocket Filler**  
DF605  
Length: 6500



**Transom B2B Adapter**  
CA465  
Length: 6500  
**To suit 101mm frame**

## Hardware/Accessories



**GW380217-CD1**  
Chainwinder



**Corner Stake**  
CS450



**Bulb Seal**  
PX0644



**Sash Flap Seal**  
PF0924



**Q-Lon Acoustic  
Seal**  
QL48750



**Glazing Wedge  
26mm**  
PF0513



**Glazing Wedge  
28mm**  
PF0518-4



**Glazing Wedge  
30mm**  
PF0519-5



**Glazing Tape**  
T10

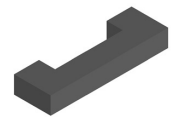

**Chain Winder Foam  
Block**  
NP383

# Ultramax Plus Awning/ Casement Window

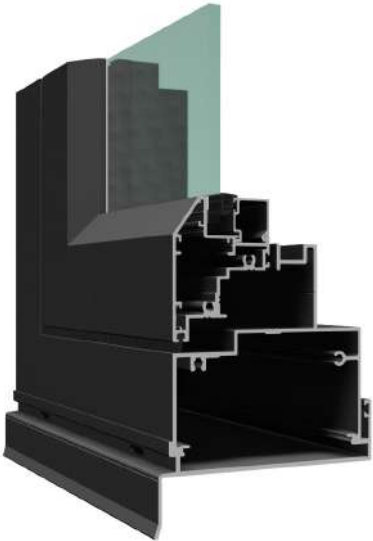

**SINGLE GLAZED**

6.38mm - 16mm

**DOUBLE GLAZED**

24mm

The Ultramax range of Awning and Casement windows are the ultimate products. Using Truth hardware, we are able to achieve large sash sizes. The Ultramax Plus Awning/Casement is designed around the 10055-DG Framing system (pg. 14) and TRUTH hardware.

PERFORMANCE

FEATURES

**Performance ratings**

N3 Non - Exposed

**Serviceability**

Up to  
1000 Pa

**Ultimate Pressure**

Up to  
1400 Pa

**Water Penetration**

Up to  
300 Pa

**Acoustic ratings**

**RW**  
29-36

- The Ultramax Plus Awning/Casement integrates with the 10055-DG frame system.
- The Ultramax Casement integrates with the 10044-SG frame system.
- Combinations with Hung Doors and Awning Sashes.
- A large range of sub framing options available.

# Centre Glazed Ultramax Plus Awning/ Casement Window

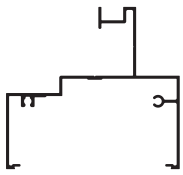

**Head/Sill**  
ULT-F400  
Length: 6500

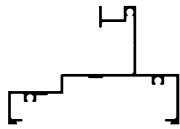

**Low Profile Head/Sill**  
ULT-F31  
Length: 6500

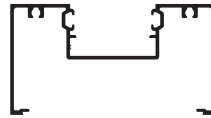

**Frame**  
DF400  
Length: 6500

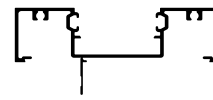

**Low Profile Frame**  
DF414  
Length: 6500

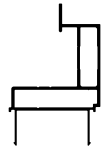

**Jamb Adapter**  
ULT-J401  
Length: 6500

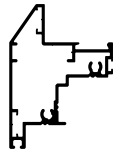

**Sash**  
ULT-S402  
Length: 6500



**Sash Bead Single Glazed**  
ULT-B14  
Length: 6500

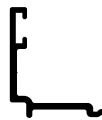

**Sash Bead Double Glazed**  
ULT-B30  
Length: 6500



**Pocket Filler**  
DF605  
Length: 6500

## Hardware /Accessories



**Bulb Seal**  
PX0644



**Sash Flap Seal**  
PF0924



**Q-Lon Acoustic Seal**  
QL48750

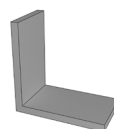

**Ultramax Sash Corner Stake**  
CS440



**Sash Corner Flute**  
CS51



**Glazing Wedge 6mm**  
PF0513



**Glazing Wedge 8mm/24mm**  
PF0518-4



**Glazing Tape**  
T10



**Chain Winder Foam Block**  
NP383

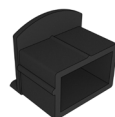

**Sill End Cap**  
ECP1

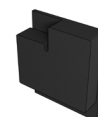

**Jamb End Cap Left**  
EC-ULTL



**Jamb End Cap Right**  
EC-ULTR

# Centre Glazed Ultramax Casement



## Profiles



**Frame**  
CA417  
Length: 6500

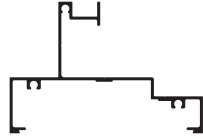

**Head/Sill**  
ULT-F26  
Length: 6500

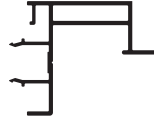

**Jamb Adapter**  
ULT-J16  
Length: 6500

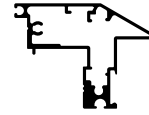

**Casement Sash**  
ULT-S62  
Length: 6500



**14mm Pocket  
Glazing Bead**  
ULT-B14  
Length: 6500



**33mm Pocket  
Glazing Bead**  
ULT-B30  
Length: 6500

## Hardware /Accessories



**Bulb Seal**  
PX0644



**Sash Flap Seal**  
PF0924



**Q-Lon Acoustic  
Seal**  
QL48750



**Ultramax Sash  
Corner Stake**  
CS420



**Sash Corner Flute**  
CS51



**Glazing Wedge  
6mm**  
PF0513



**Glazing Wedge  
8mm/24mm**  
PF0518-4



**Glazing Tape**  
T10



**Chain Winder Foam  
Block**  
NP383

# Centre Glazed Truth Awning Hardware



## Awning Operator Kits

SASH WIDTH	SASH HEIGHT	WEIGHT LIMIT	OPERATOR KIT
450 - 1800	500 - 699	26KG	T-AWN1.SS
450 - 1800	700 - 899	45KG	T-AWN2.SS
450 - 1800	900 - 1050	53KG	T-AWN3.SS
450 - 1499	1051 - 1200	58KG	T-AWN4.SS
450 - 1499	1201 - 1600	80KG	T-AWN5.SS
450 - 1499	1601 - 2100	136KG	T-AWN6.SS



## Operator Handles

LOCKING	SILVER	BLACK	WHITE
No	T-12614.01	T-12614.02	T-AWN1.SS
Yes	T-14783.01	T-14783.02	T-AWN2.SS



## Locking Kits

SASH HEIGHT	LOCKING TYPE	QUANTITY	HANDLES	LOCKING KIT
500 - 1600	Single Point	2	2	T-SPT.SS
1601 - 2100	Multi Point	1	2	T-MPT1.SS



## Locking Handles

LOCKING TYPE	SILVER	BLACK	WHITE
Single Point	T-24.32.01	T-24.32.02	T-24.32.32
Multi Point	T-24.33.01	T-24.33.01	T-24.33.32



## Cylinder

CYLINDER
LF-WC-1





# Ultramax Sliding Window

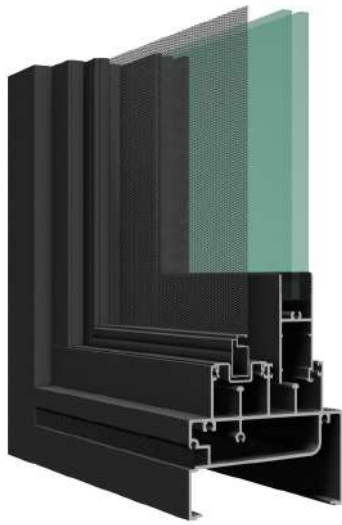

## SINGLE GLAZED

4mm-6.38mm

## DOUBLE GLAZED

18mm

The Ultramax Sliding Window integrates and was designed around the 10055-DG Centre Glazed system, a popular choice for schools, nursing homes and high end residential homes. With a maximum sash size of 2200mm x 900mm and a weight limit of 100kg panels, the Ultramax is the ultimate sliding window.

## PERFORMANCE

### Performance ratings

N3 Non - Exposed

### Serviceability

Up to  
1000 Pa

### Ultimate Pressure

Up to  
2000 Pa

### Water Penetration

Up to  
300 Pa

### Acoustic ratings

RW

24-33

## FEATURES

- Integrates seamlessly with the 10055-DG framing system, as well as the Ultramax Awning/ Casement windows and Ultramax apartment door.
- Combinations of sliding and fixed panels.
- Includes an integrates sump sill/transom.
- A large range of sub framing options available.
- Internal or external glazed system.
- Captive wedge glazing system available for sidelights, highlights and lowlights.

# Centre Glazed Ultramax Sliding Window Profiles

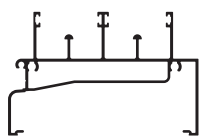

**Sill / Transom**  
DF416  
Length: 6500

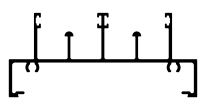

**Low Profile Sill**  
DF415  
Length: 6500

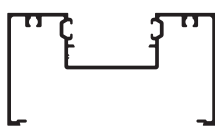

**Frame**  
DF400  
Length: 6500

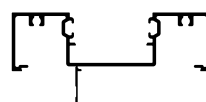

**Low Profile Frame**  
DF414  
Length: 6500

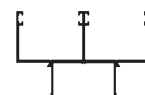

**Jamb Adapter**  
DF410  
Length: 6500



**Pocket Filler**  
DF605  
Length: 6500  
To suit DF400



**Track Flat Filler**  
DGS87  
Length: 6000  
To suit DF415/  
DF416



**Flyscreen Channel Adapter**  
DGS88  
Length: 6000



**Plant-On Interlock Flyscreen Adapter**  
DGS89  
Length: 6000

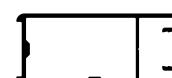

**S/G Lock Stile**  
DGS92  
Length: 6000

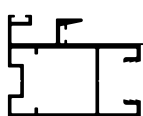

**S/G Interlock**  
CSD6  
Length: 4900/6500

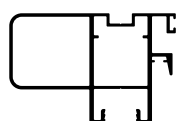

**S/G H/D Interlock**  
STK4  
Length: 4900/6500



**S/G Male Stile**  
CSD5  
Length: 4900/6500

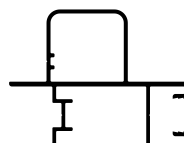

**S/G Female Stile**  
STK7  
Length: 6500

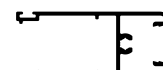

**S/G Rail**  
CSD4  
Length: 6500



**D/G Lock Stile**  
DGS98  
Length: 6500



**D/G Interlock**  
DGS97  
Length: 4900/6500

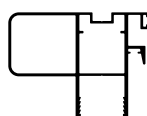

**D/G H/D Interlock**  
DGS80  
Length: 4900/6500



**D/G Male Stile**  
DGS96  
Length: 4900/6500

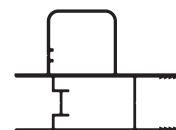

**D/G Female Stile**  
DGS82  
Length: 6500



**D/G Rail**  
DGS81  
Length: 6500

# Center Glazed Ultramax Sliding Window Profiles



**6.38mm Channel Rubber**  
PF0636



**5mm Channel Rubber**  
PF0843



**4mm Channel Rubber**  
PF0742



**18mm Channel Rubber**  
PF0830



**Co-Ex Sill Baffle**  
PX0040



**Mortise Sliding Window Lock Kit**  
DN560



**Narrow Dummy Roller**  
DR4



**40kg Narrow Roller**  
DR3



**100KG Dual Wheel Roller**  
8358 (CR9)



**Restrictor Lock**  
DS255U



**Anti Lift Block**  
DS470



**10mm Spacer Block**  
LB2



**5.5mm Wool pile**  
PB48550

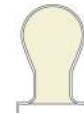

**Q-Lon Acoustic Seal**  
QL48750



**Fixing L Bracket**  
LB1



**Interlock Cover**  
EC60  
Available in black, grey, and white

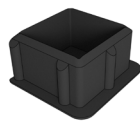

**DGS82 End Cap**  
ECD27



**10mm Hole Plug**  
HP10



**Sill Gasket Suit DF416**  
GF109



**Narrow Sill Gasket Suit DF415**  
GF108

# Ultramax Double Hung Window



The latest entry into the Ultramax window series, the Ultramax Double Hung Window offers the benefits of a counter-balanced double hung window into a commercial frame. With multiple adapters available, the Ultramax Double Hung Window can be coupled with any of the 100mm or 150mm center glazed frames.

## FEATURES

- Innovative adjustable pulley for simple assembly.
- Inner frame can be assembled on site.
- Simple cord mounting mechanism.
- Couples with any 100mm or 150mm center glazed frame.
- Large sash sizes.
- Optional sub framing available.

### **SINGLE GLAZED**

4mm - 6.38mm

### **DOUBLE GLAZED**

18mm

# Center Glazed Ultramax Double Hung Window

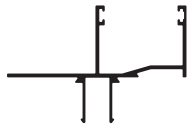

**S/G head/Sill Adapter**  
DHW111  
Length: 6500  
To suit CA460



**S/G Jamb Adapter**  
DHW110  
Length: 6500  
To suit CA460



**10055-DG Pocket Reducer**  
DF606  
Length: 6500  
To suit DF400

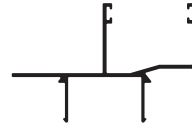

**10044-DG Head/Sill Adapter**  
DHW116  
Length: 6500  
To suit CA500



**10044-DG Jamb Adapter**  
DHW115  
Length: 6500  
To suit CA500

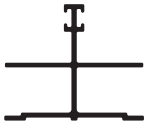

**Center Jamb Guide**  
DHW92  
Length: 6000



**Outer Jamb Guide**  
DHW93  
Length: 6000



**S/G Rail**  
DHW100  
Length: 6500



**S/G Stile**  
DHW101  
Length: 6000



**D/G Rail**  
DHW102  
Length: 6000



**S/G Stile**  
DHW103  
Length: 6000



**Interlock Insert**  
DHW105  
Length: 6000



**Handle Insert**  
DHW104  
Length: 6000



**Track Flat Filler**  
DGS87  
Length: 6000

## Hardware /Accessories



**6.38mm Channel Rubber**  
PF0636



**5mm Channel Rubber**  
PF0843



**4mm Channel Rubber**  
PF0742



**18mm Channel Rubber**  
PF0830



**Bump Strip**  
BS473

# Center Glazed Ultramax Double Hung Window Hardware/Accessories



**Double Hung  
Lock Kit - Chrome**  
DHL110-SC



**Double Hung  
Lock Kit - Black**  
DHL110-BLK



**Adjustable  
Pulley**  
CR110



**3mm Sash  
Cord**  
DHC110

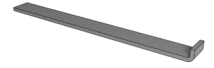

**Cord Retaining  
Clip**  
DHR110



**Q-Lon Seal**  
QEZ48



**6.5mm Woolpile**  
PB48650

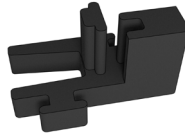

**Interlock End Cap  
Left**  
EC30L

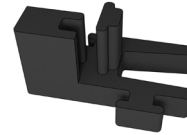

**Interlock End Cap  
Right**  
EC30R

# 15055-DG Center Glazed



The 15055-DG Center Glazed system is our largest Center Glazed frame. With a 38mm glazing pocket, it will accept a maximum DGU thickness of 32mm. It can also be single glazed using reducers. 15055-DG Center Glazed integrates with the following systems: AluCOMM Hinge Door Panels (pg. 72), Flat Sash (pg. 64), 3-track Apartment doors (pg. 59), 150mm Sub-Framing (pg. 56).

## FEATURES

- Captive Wedge system available for both single and double glazing.
- Combinations with Hinge Doors, Awning sashes and the Ultramax Stacking Apartment Door.
- Uses an overlapping 60mm Flat Sash with a Hook Head system.
- Install using a sub framing (Subsill & Sub Head).
- A large range of sub framing options available.
- All subsills have an injection moulded end cap available to assist with subsill sealing.

### SINGLE GLAZED

4mm - 10.38mm

### DOUBLE GLAZED

26mm - 32mm

### FRAME DIMENSIONS

150mm x 55mm



# Center Glazed Ultramax Double 15055-DG Profiles

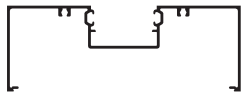

**Frame**  
DF600  
Length: 6500

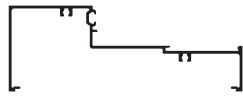

**Sill**  
DF601  
Length: 6500

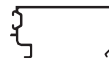

**Sill Bead**  
DF602  
Length: 6500



**Adapter**  
DF603  
Length: 6500

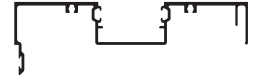

**Split Mullion**  
DF604  
Length: 6500

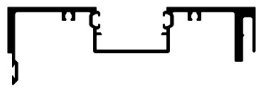

**15055 Heavy Duty Split Mullion**  
DF614  
Length: 6500

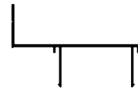

**Sash Stop**  
DF607  
Length: 6500



**45mm Door Stop**  
DF608  
Length: 6500



**Pocket Filler**  
DF605  
Length: 6500



**S/G Pocket Reducer**  
DF606  
Length: 6500



**S/G Reducer**  
DF610  
Length: 6500



**S/G Sill Bead**  
DF611  
Length: 6500



**Reveal Adapter**  
CAD019  
Length: 6500  
**To suit 150mm frame**

## Hardware /Accessories



**Captive Wedge**  
22mm-26mm  
PX0096



**Captive Wedge**  
28mm  
PX0005



**Captive Wedge**  
30mm-32mm  
PX0026



**Glazing Wedge**  
22mm  
PF0774-1



**Glazing Wedge**  
24mm/30mm  
PF0774-3



**Glazing Wedge**  
26mm  
PX0085



**Glazing Wedge**  
28mm  
PF0774-2



**Glazing Wedge**  
32mm  
PF0774-5



**Split Mullion V Seal**  
PX0075



**Weephole cover**  
WHC1239

# 10055-SG Front Glazed



10055-SG Single Glazed Front Glazed system offers a superior external finish. With the use of structurally glazed split mullions, you are able to achieve a continuous glass facade on your next project. 10055-SG Front Glazed integrates with the following systems: AluCOMM Hinge Door Panels (pg. 72), 100mm Sub Framing (pg. 55), Flat Sash (pg. 52).

## FEATURES

- Captive Wedge system available for 6-10.38mm glazing.
- Combinations with Hinge Doors and Awning sashes.
- Split mullions are able to achieve the look of continuous glass.
- Uses an overlapping 60mm Flat Sash with a Hook Head system.
- A large range of sub framing options available.
- Externally glazed system.

### FRAME DIMENSIONS

100mm x 55mm

### SINGLE GLAZED

4mm - 10.38mm

### Acoustic ratings

RW

30-37

# Front Glazed 10055-SG Profiles

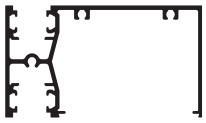

**Mullion**  
FG112  
Length: 6500



**Female Split Mullion**  
FG117  
Length: 6500



**Male Split Mullion**  
FG118  
Length: 6500



**Female Split Mullion**  
FG115  
Length: 6500



**Male Split Mullion**  
FG116  
Length: 6500

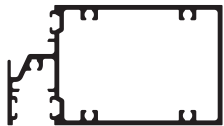

**Externally Glazed Transom Sill**  
FG108  
Length: 6500

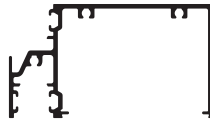

**Externally Glazed Transom**  
FG114  
Length: 6500



**Glazing Bead**  
FDG509  
Length: 6500

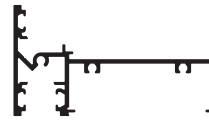

**Internally Glazed Sill**  
FG106  
Length: 6500



**Internally Glazed Sill Bead**  
FG107  
Length: 6500



**Pocket Filler**  
CA409  
Length: 6500



**Awning Stop**  
FG110  
Length: 6500



**Door Stop**  
FG119  
Length: 6500



**Flat Filler**  
CA304  
Length: 6500

## Hardware /Accessories



**Split Mullion V Seal**  
PX0075



**Captive Wedge 4mm-6mm**  
PX0005



**Captive Wedge 8mm-10mm**  
PX0026



**Glazing Wedge 4mm**  
PF0774-1



**Glazing Wedge 5mm**  
PF0774-2



**Glazing Wedge 6mm**  
PF0774-3



**Glazing Wedge 8mm**  
PF0774-5



**Glazing Wedge 10mm**  
PF0829

# 15055-SG Front Glazed



The 15055-SG Single Glazed Front Glazed system uses structurally glazed split mullions to achieve a continuous glass facade. It also has sill and transom options to allow external or internal glazing. This is a huge advantage on multi story buildings and houses. 15055-SG Front Glazed integrates with the following systems: AluCOMM Hinge Door Panels (pg. 72), 150mm Sub Framing (pg. 56), Flat Sash (pg. 52).

## FEATURES

- Captive Wedge system available for 6-10.38mm glazing.
- Combinations with Hinge Doors and Awning sashes.
- Split mullions are able to achieve the look of continuous glass.
- Uses an overlapping 60mm Flat Sash with a Hook Head system.
- A large range of sub framing options available.
- Externally glazed system.

### SINGLE GLAZED

4mm - 10.38mm

### FRAME DIMENSIONS

150mm x 55mm

# Front Glazed 15055-SG Profiles



**Main Frame**  
FG603  
Length: 6500

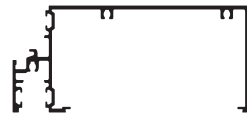

**Transom Sill**  
FG601  
Length: 6500



**Half Bead**  
FDG507  
Length: 6500  
**To suit FG601**

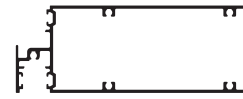

**Box Transom**  
FG602  
Length: 6500



**Full Bead**  
FDG509  
Length: 6500  
**To suit FG602**



**Female Split Mullion**  
FG605  
Length: 6500

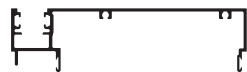

**Male Split Mullion**  
FG606  
Length: 6500



**Internally Glazed Sill**  
FG607  
Length: 6500

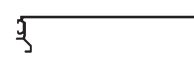

**Internal Sill Bead**  
FG608  
Length: 6500  
**To suit FG607**



**Self-Mating Blind Mullion**  
FG609  
Length: 6500



**Pocket Filler**  
CA409  
Length: 6500



**Awning Stop**  
FG110  
Length: 6500



**Door Stop**  
FG119  
Length: 6500



**112mm Flat Filler**  
FG604  
Length: 6500  
**To suit FG603/  
FG601/FG607**

## Hardware /Accessories



**Split Mullion V Seal**  
PX0075



**Captive Wedge 4mm-6mm**  
PX0005



**Captive Wedge 8mm-10mm**  
PX0026



**Glazing Wedge 4mm**  
PF0774-1



**Glazing Wedge 5mm**  
PF0774-2



**Glazing Wedge 6mm**  
PF0774-3



**Glazing Wedge 8mm**  
PF0774-5



**Glazing Wedge 10mm**  
PF0829

# 10055-DG Front Glazed



## DOUBLE GLAZED

26mm - 32mm

## FRAME DIMENSION

100mm x 55mm

The 10055-DG Double Glazed Front Glazed system offers a superior external finish with the added benefit of accepting DGU's up to 32mm. With the use of structurally glazed split mullions, you are able to achieve a continuous glass facade on your next project. 10055-DG Front Glazed integrates with the following systems: AluCOMM Hinge Door Panels (pg. 72), 100mm Sub Framing (pg. 55), Flat Sash (pg. 52), 10055-DG Inline Sash (pg. 23).

## PERFORMANCE

### WERS

#### U-Value

2.4-3.3

#### SHGC

0.35-0.59

#### TVW

0.3-0.64

### Performance Ratings:

#### N6 & C3 Non Exposed

#### Serviceability

Up to  
2000 Pa

#### Ultimate Pressure

Up to  
4500 Pa

#### Water Penetration

Up to  
600 Pa

### Acoustic Ratings

#### RW (Fixed)

31-41

## FEATURES

- Captive Wedge system available for 26-32mm glazing.
- Combines with Hinge Doors and Awning sashes.
- A large range of sub framing options available.
- Internally or externally glazed system.

# Front Glazed 10055-DG Profiles

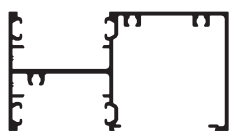

**Frame**  
FDG511  
Length: 6500



**Male Split Mullion**  
FDG506  
Length: 6500



**Female Split Mullion**  
FDG505  
Length: 6500

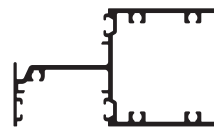

**Externally Glazed Sill/Transom**  
FDG508  
Length: 6500



**Externally Glazed Sill/Transom**  
FDG509  
Length: 6500  
**To suit FDG508**

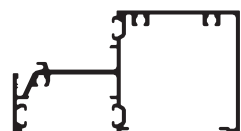

**Externally Glazed Sill/Transom**  
FDG512  
Length: 6500



**External Bead**  
FDG507  
Length: 6500  
**To suit FDG512**



**Internal Sill**  
FDG502  
Length: 6500



**Internal Sill Bead**  
FDG503  
Length: 6500  
**To suit FDG502**



**46mm D/G pocket Filler**  
FDG516  
Length: 6500  
**To suit FDG505/  
FDG506**

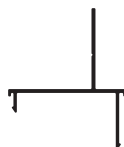

**Awning Sash Stop**  
FDG504  
Length: 6500  
**To suit FDG511/  
FDG505/FDG506**



**Door Stop**  
FDG514  
Length: 6500  
**To suit FDG511**



**46mm Flat Filler**  
FDG513  
Length: 6500  
**To suit FDG511/  
FDG512**

## Hardware /Accessories



**Captive Wedge**  
22mm-26mm  
PX0096



**Captive Wedge**  
28mm  
PX0005



**Captive Wedge**  
30mm-32mm  
PX0026



**Glazing Wedge**  
22mm  
PF0774-1



**Glazing Wedge**  
24mm/30mm  
PF0774-3



**Glazing Wedge**  
26mm  
PX0085



**Glazing Wedge**  
28mm  
PF0774-2



**Glazing Wedge**  
32mm  
PF0774-5



**Split Mullion V Seal**  
PX0075

# 10055-DG Inline Sash



## DOUBLE GLAZED

26mm - 30mm

## FRAME DIMENSIONS

100mm x 55mm

The 10055-DG Front Glazed Inline Sash suite is a brand new system designed to seamlessly integrate with the 10055-DG Front Glazed framing system. The sash closes flush with the frame, giving the Inline Sash an incredibly clean finish. It includes a dedicated head, transom and sill to allow for quick and easy installation. It adds a new level of versatility to the 10055-DG Front Glazed system and is the perfect addition to your next commercial project. 10055-DG Inline Sash is designed to integrate with the 10055-DG Front Glazed system and the following systems: AluCOMM Hinge Door Panels (pg. 72), AluCOMM Hinge Door (pg. 72), 100mm Sub Framing (pg. 55), 150mm Sub Framing (pg. 56), Flat Sash (pg. 52).

## PERFORMANCE

### Performance Ratings:

#### N5 & C2 Non Exposed

Serviceability	Ultimate Pressure	Water Penetration
Up to 1500 Pa	Up to 4000 Pa	Up to 450 Pa

## FEATURES

- Stunning inline sash profile that closes flush with the frame.
- Integrates seamlessly with the 10055-DG Front Glazed framing system.
- Dedicated framing profiles for ease of installation.
- Combinations with Hinge Doors and Awning sashes.
- A large range of sub framing options available.



# Front Glazed 10055-DG Inline Sash Profiles

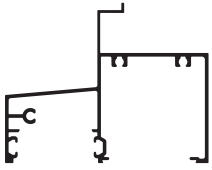

**Inline Sash Sill**  
FDG519  
Length: 6500

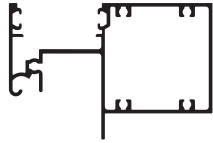

**Inline Sash Head**  
FDG518  
Length: 6500

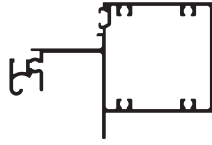

**Beaded Inline Sash Transom**  
FDG517  
Length: 6500

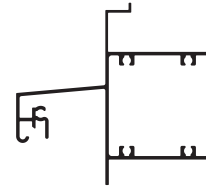

**Inline Sash Over Sash Transform**  
FDG523  
Length: 6500

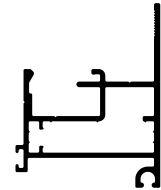

**Inline Sash**  
FDG520  
Length: 6500

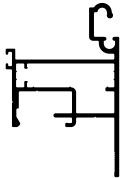

**Inline Hook Sash**  
FDG522  
Length: 6500



**Sash Stop**  
FDG521  
Length: 6500  
**To suit FDG511**



**D/G Commercial Sash Bead**  
CA703  
Length: 6500

## Hardware /Accessories



**GW380217-CD1**  
Chainwinder



**Corner Stake**  
CS450  
**To suit FDG520/  
FDG522**



**Bulb Seal**  
PX0644



**Sash Flap Seal**  
PF0924



**Glazing Wedge 26mm**  
PF0513



**Glazing Wedge 28mm**  
PF0518-4



**Glazing Wedge 30mm**  
PF0519-5



**Glazing Tape**  
T10

# 15055-DG Inline Sash



The 15055-DG Front Glazed Inline Sash suite is a brand new system designed to seamlessly integrate with the 15055-DG Front Glazed framing system. The sash closes flush with the frame, giving the Inline Sash an incredibly clean finish.

It includes a dedicated head, transom and sill to allow for quick and easy installation. It adds a new level of versatility to the 15055-DG Front Glazed system and is the perfect addition to your next commercial project.

## FRAME DIMENSIONS

150mm x 55mm

## DOUBLE GLAZED

26mm - 30mm

## PERFORMANCE

### Performance Ratings:

#### N5 & C2 Non Exposed

Serviceability	Ultimate Pressure	Water Penetration
----------------	-------------------	-------------------

Up to  
1500 Pa

Up to  
4000 Pa

Up to  
450 Pa

## FEATURES

- Stunning inline sash profile that closes flush with the frame.
- Integrates seamlessly with the 15055-DG Front Glazed framing system.
- Dedicated framing profiles for ease of installation.
- Combines with Hinge Doors and Awning sashes.
- A large range of sub framing options available.

# Front Glazed 15055-DG Inline Sash Profiles

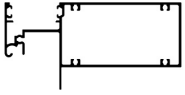

**Inline Sash Hook Head**  
FDG618  
Length: 6500

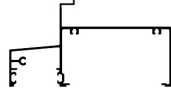

**Inline Sash Sill**  
FDG619  
Length: 6500

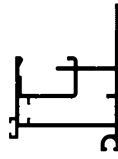

**Inline Sash**  
FDG520  
Length: 6500

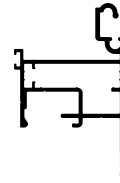

**Inline Hook Sash**  
FDG522  
Length: 6500



**D/G Commercial Sash Bead**  
CA703  
Length: 6500

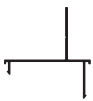

**Sash Stop**  
FDG504  
Length: 6500  
To suit FDG600

## Hardware /Accessories



**GW380217-CD1**  
Chainwinder



**Corner Stake**  
CS450



**Bulb Seal**  
PX0644



**Sash Flap Seal**  
PF0924



**Glazing Wedge**  
26mm  
PF0513



**Glazing Wedge**  
28mm  
PF0518-4



**Glazing Wedge**  
30mm  
PF0519-5



**Glazing Tape**  
T10

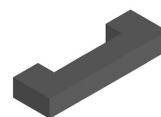

**Chain Winder Foam Block**  
NP383

# 15055-DG Front Glazed



## DOUBLE GLAZED

24mm - 32mm

## FRAME DIMENSION

150mm x 55mm

The 15055-DG Double Glazed Front Glazed system is our largest and most versatile Front Glazed system. With up to 32mm DGU's and the use of structurally glazed split mullions, you are able to achieve a continuous glass facade. **15055-DG Front Glazed integrates with the following systems:** AluCOMM Hinge Door Panels (pg. 72), Flat Sash (pg. 52), 15055 Curtain Wall (pg. 46).

## PERFORMANCE

### WERS Ratings:

#### U-Value

2.8-3.6

#### SHGC

0.3-0.64

#### TVW

0.33-0.68

### Performance Ratings:

N6 & C3 Non Exposed

#### Serviceability

Up to  
2000 Pa

#### Ultimate Pressure

Up to  
4500 Pa

#### Water Penetration

Up to  
600 Pa

## FEATURES

- Captive Wedge system available for 6-10.38mm glazing
- Combinations with Hinge Doors and Awning sashes
- Split mullions are able to achieve the look of continuous glass
- Uses an overlapping 60mm Flat Sash with a Hook Head system
- A large range of sub-framing options available
- Externally glazed system

# Front Glazed 15055-DG Profiles

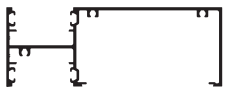

**Frame**  
FDG600  
Length: 6500

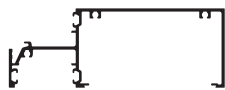

**Externally Glazed Sill/Transom**  
FDG601  
Length: 6500



**External Bead**  
FDG507  
Length: 6500  
**To suit FDG601**

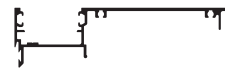

**Male Split Mullion**  
FDG602  
Length: 6500



**Female Split Mullion**  
FDG603  
Length: 6500

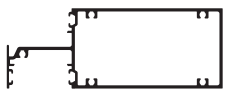

**Externally Glazed Sill/Transom**  
FDG606  
Length: 6500



**External Glazing Bead**  
FDG509  
Length: 6500  
**To suit FDG606**



**Sill Transom**  
FDG604  
Length: 6500



**Sill Bead**  
FDG605  
Length: 6500  
**To suit FDG604**



**90mm Flat Filler**  
CA102  
Length: 6500  
**To suit FDG600/  
FDG601**



**Sash Stop**  
FDG504  
Length: 6500  
**To suit FDG602/  
FDG603/FDG600**



**46mm D/G Pocket Filler**  
FDG516  
Length: 6500  
**To suit FDG602/  
FDG603/**



**45mm Door Stop**  
FDG514  
Length: 6500  
**To suit FDG600**



**2 Piece Plant On Door Stop**  
CA459  
Length: 6500

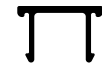

**Door Stop Pocket Filler**  
CA305  
Length: 6500  
**To suit CA459**

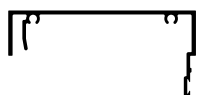

**Blind Split Mullion**  
CA117  
Length: 6500

## Hardware /Accessories



**Captive Wedge**  
22mm-26mm  
PX0096



**Captive Wedge**  
28mm  
PX0005



**Captive Wedge**  
30mm-32mm  
PX0026



**Glazing Wedge**  
22mm  
PF0774-1



**Glazing Wedge**  
24mm/30mm  
PF0774-3

# Hardware /Accessories



**Glazing Wedge  
26mm  
PX0085**



**Glazing Wedge  
28mm  
PF0774-2**



**Glazing Wedge  
32mm  
PF0774-5**



**Split Mullion  
V Seal  
PX0075**

# 15055-DG Slab Overlay



The 15055 Slab Overlay system has been designed to be used in conjunction with the 15055 DG Front Glazed System. It allows you to create a full glass facade in applications where slab concrete floors are used.

## FEATURES

- Achieves a true top to bottom glass facade for a stunning finish.
- Single Glazing available using reducers.

### DOUBLE GLAZED

26mm - 32mm

### FRAME DIMENSIONS

150mm x 55mm

## PERFORMANCE

### Performance Ratings:

N5 & C2 Non Exposed

#### Serviceability

Up to  
2000 Pa

#### Ultimate Pressure

Up to  
3000 Pa

#### Water Penetration

Up to  
800 Pa

# 15055-DG Slab Overlay Profiles

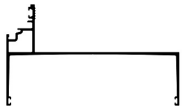

**150mm Slab  
Overlay Head**  
**CA615**  
Length: 6500  
Bead to suit  
FDG507



**Slab Overlay  
Mullion**  
**FDG608**  
Length: 6500  
Bead to suit  
FDG507

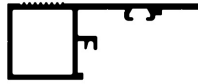

**Slab Overlay  
Jamb**  
**FDG607**  
Length: 6500  
Bead to suit  
FDG507

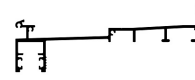

**150mm Slab  
Overlay Sub Sill**  
**SS11**  
Length: 6500  
Bead to suit  
FDG507



# 15055-DG Front Glazed Curtain Wall



The 10055-DG Front Glazed Curtain allows for a true top to bottom glass facade. It is designed as a double glazed system, but can also accept single glazing using reducers. It is the ideal solution for large commercial shopfronts. 15055-DG Front Glazed Curtain Wall system is a stand alone system that uses some profiles from the 15055-DG Front Glazed Framing System.

## FEATURES

- Achieves a true top to bottom glass facade for a stunning finish.
- Single Glazing available using reducers.

### DOUBLE GLAZED

26mm - 32mm

### FRAME DIMENSIONS

150mm x 55mm

## PERFORMANCE

### Performance Ratings:

N5 & C2 Non Exposed

#### Serviceability

Up to  
2000 Pa

#### Ultimate Pressure

Up to  
3000 Pa

#### Water Penetration

Up to  
800 Pa

# 15055-DG Front Glazed Curtain Wall Profiles

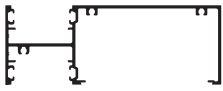

**Frame**  
FDG600  
Length: 6500

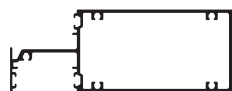

**Externally Glazed Sill/Transom**  
FDG606  
Length: 6500

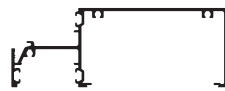

**Externally Glazed Sill/Transom**  
FDG601  
Length: 6500



**Female Transom**  
FDG620  
Length: 6500

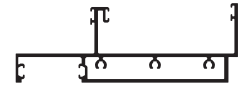

**Male Transom**  
FDG623  
Length: 6500



**Externally Glazed Bead**  
FDG509  
Length: 6500  
To suit FDG606



**Female Mullion**  
FDG621  
Length: 6500

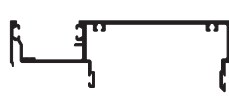

**Male Mullion**  
FDG622  
Length: 6500



**Mullion Stiffener**  
FDG627  
Length: 6500  
To suit FDG621/  
FDG622



**Transom Spigot**  
FDG624  
Length: 6500  
To suit FDG623



**S/G Adapter**  
FDG625  
Length: 6500



**S/G Reducer**  
FDG626  
Length: 6500



**External Bead**  
FDG507  
Length: 6500  
To suit FDG601

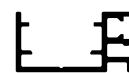

**2 Piece Plant On Door Stop**  
CA459  
Length: 6500



**Door Stop Pocket Filler**  
CA305  
Length: 6500  
To suit CA459



**Split Mullion V Seal**  
PX0075  
To suit FDG621/  
FDG622

# 10350 Flush Glazed



The 10350 Flush Glazed system is our most popular system for factories and warehouses. It offers a full glass facade with minimal exposed aluminium with, the use of integrated blind mullions. 10350 Flush Glazed framing system is a stand alone system Can accommodate both Single and Double glazing.

## DOUBLE GLAZED

24mm

## SINGLE GLAZED

6.38mm x 16mm

## FRAME DIMENSION

103.6mm x 50mm

## FEATURES

- Combinations with Hinge Doors and Awning sashes.
- Split mullions to achieve the look of continuous glass.
- Sub Sills available.
- Externally Glazed System.
- Structurally glazed system.

## PERFORMANCE

### Performance Ratings:

N4 Non Exposed

Serviceability

Up to  
1500 Pa

Ultimate Pressure

Up to  
2700 Pa

Water Penetration

Up to  
450 Pa

# Flush Glazed 10350 Profiles

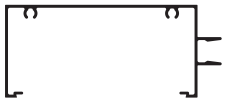

**S/G Frame**  
CA101  
Length: 6500

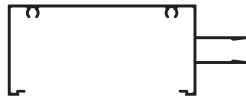

**D/G Frame**  
CA118  
Length: 6500



**Jamb/Frame**  
CA111  
Length: 6500

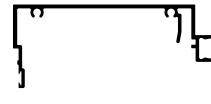

**S/G Male Split Mullion**  
CA115  
Length: 6500

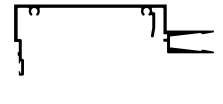

**D/G Male Split Mullion**  
CA116  
Length: 6500



**Female/Self Mating Blind Split Mullion**  
CA117  
Length: 6500



**10mm Snap Cover**  
CA107  
Length: 6500  
**6-12mm glass**



**10mm Snap Cover/Return**  
CA108  
Length: 6500  
**6-12mm glass**



**20mm Snap Cover**  
CA120  
Length: 6500  
**12-16mm glass**



**20mm Snap Cover/Return**  
CA121  
Length: 6500  
**12-16mm glass**



**D/G 36mm Snap Cover/Return**  
CA810  
Length: 6500  
**24-32mm glass**



**D/G Adapter**  
CA809  
Length: 6500  
**To suit CA101/CA115/CA111**



**D/G Plant on Base**  
CA106  
Length: 6500  
**24-32mm glass**



**S/G Plant on Base**  
CA105  
Length: 6500  
**6-16mm glass**



**90mm Flat Filler**  
CA102  
Length: 6500  
**To suit CA101/CA118/CA111**

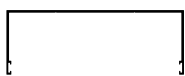

**S/G Sub Head**  
CA112  
Length: 6500  
**To suit CA101**



**D/G Sub Head**  
CA113  
Length: 6500  
**To suit CA118**

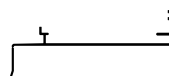

**133mm Subsill**  
SS2  
Length: 6500  
Subsill Setback: 133mm  
Frame Setback: 127mm

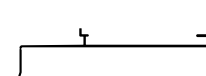

**160mm Subsill**  
SS8  
Length: 6500  
Subsill Setback: 160mm  
Frame Setback: 154mm



**Split Mullion V Seal**  
PX0075



## 64mm Office Partition

The 64mm Office Partition is designed for simple, cost effective internal partitions. The 64mm Office Partition is a stand alone system and can be coupled with the AluCOMM Hinge Door Panels (pg. 72) It utilizes a center glazed design and can be glazed up to 10.38mm.

- Suits 64mm stud.
- Internal use only.
- Compatible with 45mm and 38mm hinge doors.

<b>SINGLE GLAZED</b>	<b>FRAME DIMENSIONS</b>
4mm - 10mm	100mm x 35mm



# 64mm Office Partition profiles



**Jamb / Mullion**  
OP160  
Length: 6500



**Sill**  
OP161  
Length: 6500



**Sill Bead**  
OP162  
Length: 6500



**Frame**  
OP163  
Length: 6500



**Adapter**  
OP164  
Length: 6500



**Ceiling Channel**  
OP165  
Length: 6500



**Pocket Filler**  
OP166  
Length: 6500



**45mm Door Stop**  
OP167  
Length: 6500



**38mm Door Stop**  
OP168  
Length: 6500

## Hardware /Accessories



**Aquamac Push In Seal**  
AQ21



**38mm Door Stop Wool pile**  
PB48550

# Flat Sash



The Commercial Flat Sash suite is a highly versatile system that can be paired with any of the Centre Glazed or Front Glazed framing systems. The sash overlaps the frame when closed providing superior weather protection and sealing. The Commercial Flat Sash is an overlapping sash that uses an add-on hook hinge, making it an easy addition to any AluCOMM framing system.

## FEATURES

- Single and Double Glazing available.
- Add-on hook section for maximum compatibility.
- Integrates with all Center Glazed and Front Glazed framing systems.
- Beaded sash for on-site glazing.
- Superior sealing and protection from the elements.

### DOUBLE GLAZED

24mm

### SINGLE GLAZED

6mm x 10.38mm

### SASH HEIGHT

58mm x 37mm

# Commercial Flat Sash Profiles

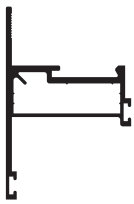

**Flat Awning Sash**  
CA470  
Length: 6500

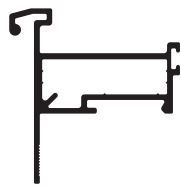

**Flat Sash w/Hinge**  
CA471  
Length: 6500



**Sash Hinge**  
CA453  
Length: 6500



**D/G Commercial Sash Bead**  
CA703  
Length: 6500

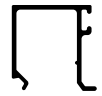

**S/G Commercial Sash Bead**  
CA412  
Length: 6500



**Commercial Chainwinder Adapter**  
CA100  
Length: 6500



**Electric Chainwinder Receiver**  
CA050  
Length: 6500



**Electric Chainwinder Cover**  
CA051  
Length: 6500

# Hardware /Accessories



**GW380217-CD1**  
Chainwinder



**Sash Corner Stake**  
CS450



**Bulb Seal**  
PX0644



**Q-Lon Acoustic Seal**  
QL48750

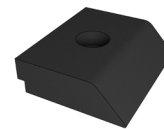

**Awning Wedge**  
AW1



**Flyscreen Clip**  
FC1



**Awning Stays**  
10kg Sash Limit  
200-4B-NF



**Awning Stays**  
20kg Sash Limit  
350-4B-NF



**Awning Stays**  
30kg Sash Limit  
500-4B-NF



**Casement Stays**  
40kg Sash Limit  
430-4BC-NF



**Stay Restrictor**  
100mm Limit  
P1097



**Glazing Wedge**  
6mm  
PX0087



**Glazing Wedge**  
8mm  
PF0518-4



**Glazing Wedge**  
10mm  
PF0519-5



**Glazing Wedge**  
24mm  
PX0086



**Glazing Tape**  
T10

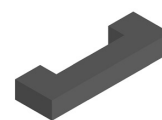

**Chain Winder Foam Block**  
NP383



# Sub Framing



We offer a wide variety of sub framing options to suit a range of our AluCOMM commercial systems. Sub framing profiles are available to suit our 100mm frame systems, 150mm frame systems, and additional sub framing including for the 7635-SG Center Glazed Framing System (76mm) and the brand new 4-Track apartment Door profiles (200mm).

All subsills have injection moulded end caps which offer superior end sealing and performance.

# 100mm Sub Framing Profiles



**Sloping Sub Sill**  
SS20  
Length: 6500  
Subsill Setback: 113mm  
Frame Setback: 107mm

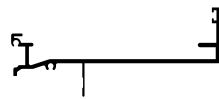

**Sub Sill with Reveal Fin**  
SS21  
Length: 6500  
Subsill Setback: 111mm  
Frame Setback: 105mm

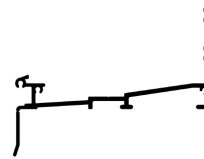

**107mm Slopped H/  
Performance Sub  
Sill**  
SS25  
Length: 6500



**122mm Sub Sill**  
SS5  
Length: 6500  
Subsill Setback: 122mm  
Frame Setback: 116mm



**133mm Sub Sill**  
SS2  
Length: 6500  
Subsill Setback: 133mm  
Frame Setback: 125mm

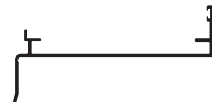

**113mm Sub Sill**  
SS1  
Length: 6500  
Subsill Setback: 113mm  
Frame Setback: 107mm

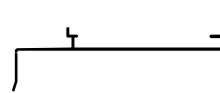

**143mm Sub Sill**  
SS7  
Length: 6500  
Subsill Setback: 143mm  
Frame Setback: 137mm



**100mm Sub Head**  
CA432  
Length: 6500



**100mm Sub  
Jamb**  
CA444  
Length: 6500



**100mm Deep Sub-  
head**  
CA495  
Length: 6500



**Sub Jamb Cover**  
CA605  
Length: 6500  
**To suit CA444**

## Hardware /Accessories



**100mm Sub  
Sill End Cap**  
EC100

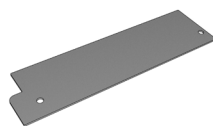

**SS20 End Cap**  
ECD120



**SS25 End Cap**  
ECD25

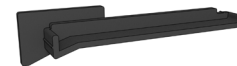

**SS21 End Cap  
Left**  
EC21L



**SS21 End Cap  
Right**  
EC21R



**Co-Ex Sill Baffle**  
PX0040



**Bulb Seal**  
PX0644



**4.8mm Wool pile**  
PB48550

100mm Sub Framing can be used with all of the 100mm AluCOMM Frames.

# 150mm Sub Framing Profiles



**150mm Sub Head**  
CA606  
Length: 6500



**150mm Sub Jamb**  
CA607  
Length: 6500

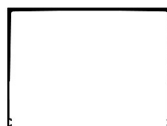

**150mm Deep Sub-head**  
CA695  
Length: 6500

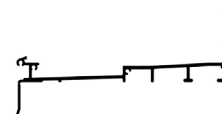

**160mm Sloped Sub Sill**  
SS15  
Length: 6500

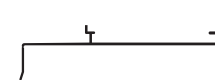

**160mm Slotted Sub Sill**  
SS8  
Length: 6500  
Subsill Setback: 160mm  
Frame Setback: 152mm



**163mm Sub Sill**  
SS3  
Length: 6500  
Subsill Setback: 163mm  
Frame Setback: 156mm

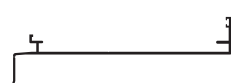

**172mm Sub Sill**  
SS4  
Length: 6500  
Subsill Setback: 172mm  
Frame Setback: 164mm

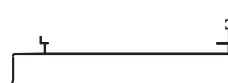

**181mm Sub Sill**  
SS10  
Length: 6500  
Subsill Setback: 181mm  
Frame Setback: 173mm



**Sub Jamb Cover**  
CA605  
Length: 6500  
**To suit CA607**

## Hardware /Accessories



**150mm Sub Sill End Cap**  
EC150



**SS15 End Cap**  
ECD16



**Co-Ex Sill Baffle**  
PX0040



**Bulb Seal**  
PX0644



**4.8mm Wool pile**  
PB48550

150mm Sub Framing can be used with all of the 150mm AluCOMM Frames.

# Gutter Sill Profiles

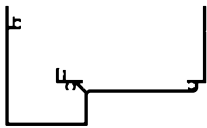

**100mm Gutter Sill  
GS1**  
Length: 6500  
To suit 101mm  
frames

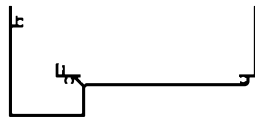

**150mm Gutter Sill  
GS2**  
Length: 6500  
To suit 150mm  
frames



**Gutter Sill Bead  
GS3**  
Length: 6500



**Gutter Sill Grate  
Clear Anodised  
GS4**  
Length: 4000

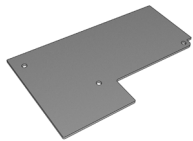

**Gutter Sill End Cap  
Suit GS1**  
ECD150  
To suit GS1

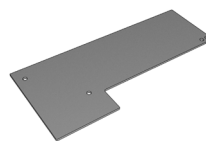

**Gutter Sill End Cap  
Suit GS2**  
ECD200  
To suit GS2

These Gutter Sill profiles can be paired with the 100mm 2-Track and 150mm 3-Track Titan and Ultramax Apartment Doors.

# Miscellaneous Framing Profiles

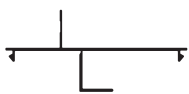

**19mm Reveal  
Adapter  
CA490**  
Length: 6500  
To suit 100mm  
frame

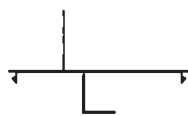

**30mm Reveal  
Adapter  
CA430**  
Length: 6500  
To suit 100mm  
frame



**Fixing Adapter  
CA451**  
Length: 6500  
To suit 100mm  
frame



**Ezy Reveal Adapter  
CA450**  
Length: 6500  
To suit 100mm frame

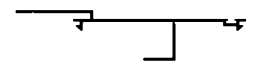

**Ezy Reveal Adapter  
CA493**  
Length: 6500  
To suit 100mm frame



**100mm Back  
to Back Adapter  
CA465**  
Length: 6500  
To suit 100mm  
frame



**90mm Flat Filler  
CA102**  
Length: 6500  
To suit 100mm  
frame



**150mm Back  
to Back Adapter  
DF620**  
Length: 6500  
To suit 150mm  
frame



**Reveal Adapter  
CAD019**  
Length: 6500  
To suit 150mm  
frame

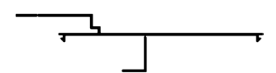

**Ezy Reveal Adapter  
150mm  
CA452**  
To suit 150mm Ezy  
Jamb & 150mm  
frame

These framing profiles can be added to all of the 100mm Center Glazed Frames and Apartment Door frames.

# Titan Apartment Door



The Titan Apartment Door is a commercial grade door designed for Apartments and high end residential applications, offering large openings with the 2, 3, 4 and 6 panel sliding configurations. With a wide range of stile options available the door can be customised to create the desired look for your next project. The Titan Apartment Door uses the Apartment Door Panels

## DOUBLE GLAZED

24mm

## SINGLE GLAZED

4mm x 10.38mm

## PERFORMANCE

### WERS

#### U-Value

2.9-6.1

#### SHGC

0.24-0.6

#### TVW

0.22-0.61

### Performance Ratings:

#### N6 & C3 Non Exposed

#### Serviceability

Up to  
9300 Pa

#### Ultimate Pressure

Up to  
2300 Pa

#### Water Penetration

Up to  
280 Pa

### Acoustic Ratings

#### RW

27-36

## FEATURES

- Integrates with 10055-DG Center Glazed.
- 150Kg Triple wheel rollers.
- Standard, Heavy Duty and Wide Stile options.
- Dedicated deep head.
- Sump sill for high water performance.
- Sub Framing Available (Sub Sill and Sub Head).

# Commercial Sliding Doors: Titan Apartment Door Profiles

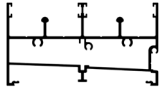

**2 Track Sill**  
CAD132  
Length: 6500

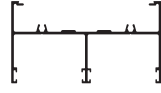

**2 Track DeepHead**  
CAD160  
Length: 6500

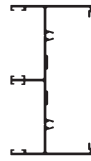

**2 Track Jamb**  
CAD161  
Length: 6500/5000

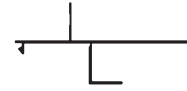

**90mm Reveal Adapter**  
CA490  
Length: 6500  
To suit CAD160/  
CAD161

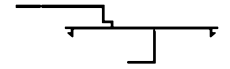

**Ezy Reveal Adapter**  
CA450  
Length: 6500  
To suit CAD160/  
CAD161

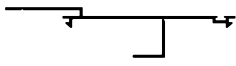

**Ezy Reveal Adapter**  
CA493  
Length: 6500  
To suit CAD160/  
CAD161

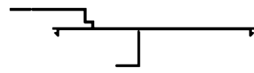

**Ezy Reveal Adapter  
150mm**  
CA452  
To suit CAD119/  
CAD130



**90mm Flat Filler**  
CA102  
Length: 6500  
To suit CAD160/  
CAD161



**Hi-Lite B2B  
Adapter**  
CA465  
Length: 6500  
To suit CAD160/  
CAD161

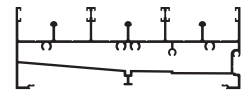

**3 Track Sill**  
CAD136  
Length: 6500



**3 Track Jamb**  
CAD119  
Length: 6500/5000

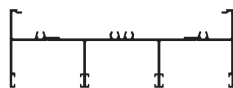

**3 Track Head**  
CAD130  
Length: 6500



**140mm Reveal Adapter**  
CAD019  
Length: 6500  
To suit CAD130/CAD119



**132mm Flat Filler**  
CA805  
Length: 6500  
To suit CAD135/  
CAD136



**150mm Back to  
BackAdapter**  
DF620  
Length: 6500  
To suit CAD160/  
CAD161



**Sill Support**  
FB2016  
Length: 3600  
To suit CAD135



**Ridged Channel  
Frame**  
CAD112  
Length: 6500



**Threshold**  
CAD138  
Length: 6500  
To suit CAD136/  
CAD132

# Ultramax Apartment Door



The Ultramax Apartment Door is our premium Apartment Door, designed to take extreme weights it's unique support base integrated into the sill; it allows pane weights of 300kg. The perfect solution for apartments and high end residential applications

---

## FEATURES

---

- Uses a drop in track system, allowing for easy replacement.
- 2 Track, 3 Track and 4 Track profiles available.
- Unique support base that transmits all of the doors weight through to the floor.
- 150Kg Triple Rollers.
- Structurally enhanced horizontal rail with the option of a glazing bead or channel rubber.
- Option of Standard, Heavy Duty or Wide Stiles.
- Sub Framing available (Sub Head and Sub Sill).

### **SINGLE GLAZED**

6.38mm - 10.38mm

### **DOUBLE GLAZED**

24mm

# Commercial Sliding Doors: Ultramax Apartment Door Profiles

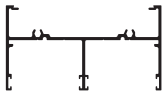

**2 Track Head**  
CAD020  
Length: 6500

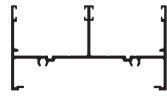

**2 Track Sill Slotted**  
CAD027  
Length: 6500



**2 Track Sill Support**  
CAD021  
Length: 6500  
To suit CAD027

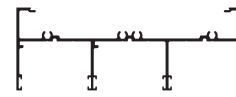

**3 Track Head**  
CAD022  
Length: 6500



**2 Track Jamb**  
CAD161  
Length: 6500/5000

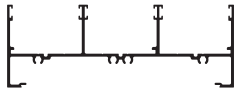

**3 Track Sill Slotted**  
CAD028  
Length: 6500

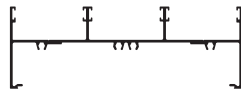

**3 Track Jamb**  
CAD119  
Length: 6500/5000



**3 Track Sill Support**  
CAD023  
Length: 6500  
To suit CAD028

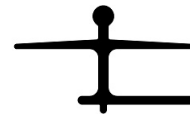

**Ultramax Drop In Runner**  
CAD042  
Length: 6500  
To suit BS33  
Bumper Stop



**Threshold**  
CAD138  
Length: 6500



**132mm Flat Filler**  
CA805  
Length: 6500  
To suit CAD022 &  
CAD028



**Intermediate Threshold**  
CAD137  
Length: 6500  
600 water pascal

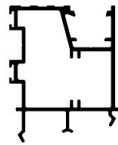

**High Performance Threshold**  
CAD139  
Length: 6500  
650+ water pascal  
To suit CA409

## 4-Track Apartment Door Profiles

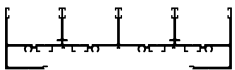

**4 Track Head/Sill**  
CAD040  
Length: 6500

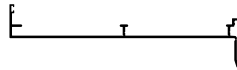

**4 Track Subsill**  
SS6  
Length: 6500  
Subsill Setback: 212mm  
Frame Setback: 206mm  
To suit CAD040

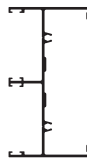

**2 Track Jamb**  
CAD161  
Length: 6500/5000



**3 Track Sill Support**  
CAD023  
Length: 6500  
To suit CAD040

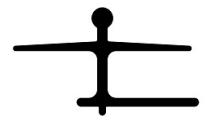

**Ultramax Drop In Runner**  
CAD042  
Length: 6500  
To suit BS33 Bumper Stop



**132mm Flat Filler (Head/Sill)**  
CA805  
Length: 6500  
To suit CAD040



**Sill Joining Plate**  
FB123  
Length: 4000



# Built-In-Flytrack Apartment Door

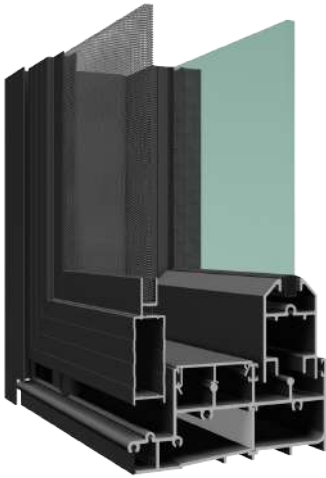

The Built-In-Flytrack Door is a commercial grade door designed for Apartments and high end residential applications, offering large openings with the 2, 3, 4 and 6 panel sliding configurations. With a wide range of stile options available the door can be customised to create the desired look for your next project.

**DOUBLE GLAZED**  
24mm

**SINGLE GLAZED**  
4mm x 10.38mm

## PERFORMANCE

### WERS

#### U-Value

2.9-6.1

#### SHGC

0.24-0.6

#### TVW

0.22-0.61

### Performance Ratings:

#### N6 & C3 Non Exposed

#### Serviceability

Up to  
9300 Pa

#### Ultimate Pressure

Up to  
2300 Pa

#### Water Penetration

Up to  
280 Pa

### Acoustic Ratings

#### RW

27-36

## FEATURES

- Integrates with 10055-DG Center Glazed.
- 150Kg Triple wheel rollers.
- Standard, Heavy Duty and Wide Stile options.
- Dedicated deep head.
- Sump sill for high water performance.
- Sub Framing Available (Sub Sill and Sub Head).

# Commercial Sliding Doors: Built-In -Flytrack Apartment Door Profiles

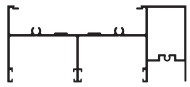

**2 Track Head with Fly Track**  
CAD169  
Length: 6500/4500

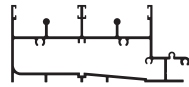

**2 Track Sill with Fly Track**  
CAD167  
Length: 6500/4500



**Fly Door Jamb**  
CAD171  
Length: 6500

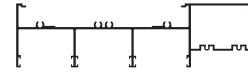

**3 Track Head with Fly Track**  
CAD170  
Length: 6500/4500

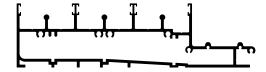

**3 Track Sill with Fly Track**  
CAD168  
Length: 6500/4500



**3 Track Jamb**  
CAD119  
Length: 6500/5000



**2 Track Jamb**  
CAD161  
Length: 6500/5000



**Double Fly Door Jamb**  
CAD172  
Length: 6500

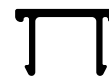

**Flydoor Jamb Pocket Filler**  
CA305  
Length: 6500  
To suit CAD171/  
CAD172



**Sill Support**  
FB2516  
Length: 4000  
To suit CAD167 &  
CAD168



**Threshold**  
CAD138  
Length: 6500  
To suit CAD168/  
CAD167



**140mm Reveal Adapter**  
CAD019  
Length: 6500  
To suit CAD119



**19mm Reveal Adapter**  
CA490  
Length: 6500  
To suit CAD169/  
CAD161

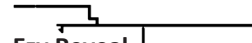

**Ezy Reveal Adaptor**  
CA452  
To suit CAD119

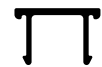

**Pocket Filler**  
CA305  
Length: 6500  
To suit CAD172/  
CAD171

## Flat Jamb Apartment Door Profiles

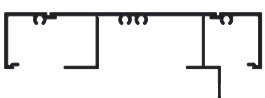

**150mm Flat Jamb**  
CAD162  
Length: 6500

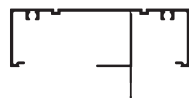

**100mm Flat Jamb**  
CAD163  
Length: 6500



**Channel with Ridge**  
CAD113  
Length: 6500

# Commercial Sliding Doors: Apartment Door Panel Profiles



**58mm Lock Stile**  
CAD150  
Length: 6500/5000  
**To suit Yarra View locks**



**76mm Lock Stile**  
CAD152  
Length: 6500  
**To suit Evolution locks**

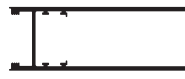

**128mm Lock Stile**  
CAD146  
Length: 6500



**Female Lock Stile**  
CAD157  
Length: 6500  
**To suit Evolution**



**Male Meeting/Corner Stile**  
CAD156  
Length: 6500



**Std. Interlock**  
CAD151  
Length: 6500/5000



**Wide Interlock**  
CAD148  
Length: 6500



**Heavy Duty Interlock**  
CAD124  
Length: 6500



**3 Panel Adapter**  
CAD018  
Length: 3000



**Female Corner Stile**  
CAD165  
Length: 3000

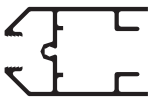

**S/G Beveled Rail**  
CAD005  
Length: 6500

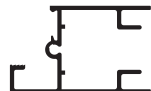

**S/G Square Rail**  
CAD114  
Length: 6500



**S/G Wide Beaded Rail**  
CAD143  
Length: 6500

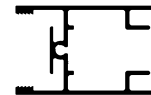

**D/G Rail**  
CAD118  
Length: 6500

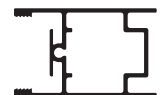

**D/G Boxed Rail**  
CAD025  
Length: 6500

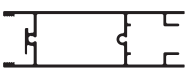

**D/G Wide Rail**  
CAD142  
Length: 6500

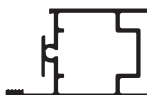

**D/G Boxed Beaded Rail**  
CAD026  
Length: 6500

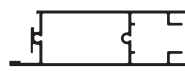

**D/G Wide Beaded Rail**  
CAD144  
Length: 6500

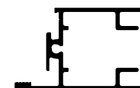

**150KG D/G Beaded Rail**  
CAD126  
Length: 6500



**S/G Pocket Adapter**  
CAD164  
Length: 6500



**S/G Rail Bead**  
CAD115  
Length: 6500



**D/G Rail Bead**  
CAD127  
Length: 6500

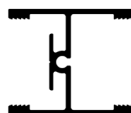

**D/G Midrail**  
CAD120  
Length: 6500

Apartment Door Panels can be used in all of the AluCOMM sliding door frames:

- Flat Jamb Apartment Door (pg. 63)
- Ultramax Apartment Door (pg. 60)
- Built-in Fly Track Apartment Door (pg. 62)
- Titan Apartment Door (pg. 70)

# Commercial Sliding Doors: Hardware Accessories



**4mm Glazing Channel**  
PF0742



**5mm Glazing Channel**  
PF0843



**6.38mm Glazing Channel**  
PF0636



**24.76mm Glazing Channel**  
PF0551



**Anti Binding Rubber**  
PF0630



**Co-Ex Sill Baffle**  
PX0040

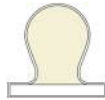

**Q-Lon Acoustic Seal**  
QL69650



**Fixing Block**  
FB6



**10mm Spacer Block**  
LB2



**In Track Door Stop**  
BS2



**Apartment Door Stop For Shallow Drop-In Track**

**BS3**  
To suit CAD042



**Weephole Cover**  
WHC1239



**Bumper Stop (Satin Chrome)**  
1690-C



**Weephole Cover**  
WHC1239



**Apartment Door Interlock Block**  
LB3



**10mm Hole Plug**  
HP10

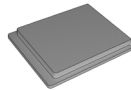

**H/D Interlock End Cap**  
ECD124

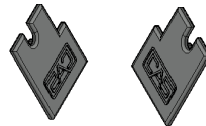

**Apartment door interlock end cap** - pairs L & R  
LB5-R and LB5-L



**Apartment Door End Cap**  
**EC25**  
50 left / 50 right



**2 Track Sill Gasket**  
ADG100



**3 Track Sill Gasket**  
ADG150



**4 Track Head/Sill Gasket**  
ADG220



**2 Track BIF Sill Gasket**  
ADG120



**3 Track BIF Sill Gasket**  
ADG200

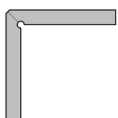

**Corner Bracket 63mm**  
JC1

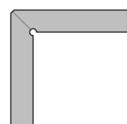

**Corner Bracket 68mm**  
JC2

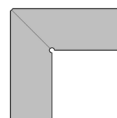

**Corner Bracket 88mm**  
JC3

# Commercial Sliding Door Rollers



**Dummy Roller**  
100kg  
3136 (DR1)



**2 Wheel Roller**  
100kg  
8358 (CR9)



**2 Wheel Roller**  
150kg  
Suit CAD126 Rail  
8173



**3 Wheel Roller**  
150kg  
8387



**5 Wheel Roller**  
200kg  
8275

## Evolution Sliding Lock Kits

The Evolution Sliding Door Lock Suite is sold 5 kit options.

All kits include a lock body assembly, a cylinder with turn snib, a recessed strike plate and fitting kit, a set of escutcheons and a set of handles.

LOCK KIT	COLOUR	HANDLES
<b>EVOLUTION-KIT1</b> Black D-Handles	Black	D-Handles
<b>EVOLUTION-KIT2</b> Black Flush Pull Handles	Black	Flush Pull Handles
<b>EVOLUTION-KIT3</b> Stainless Flush Pull Handles	Stainless Steel	Flush Pull Handles
<b>EVOLUTION-KIT4</b> Matched Powdercoating Handles	Matched Powder Coating	D-Handles
<b>EVOLUTION-KIT5</b> Matched Powdercoating Flush Pull Handles	Matched Powder Coating	Flush Pull Handles



Flush Pull Handle  
Code: **DS575**



D Pull Handle  
Code: **DN194**

# Additional Lock Options



Umbra Flush Mount  
Sliding Door Lock  
**DS2500**



D-Pull Handle  
**Avon D Handle**

# Yarra View Edge Sliding Locks



Yarra View Lock  
Black  
YARRAVIEW



Yarra View Lock  
White  
YARRAVIEW



Yarra View  
5-pin Cylinder  
YV-CYLINDER



Yarra View  
Wafer Cylinder  
YV-WAFER  
CYLINDER



Yarra View  
Catch plate  
YV-CATCHER



Yarra View  
Dummy Handle  
YV-DUMMY  
HANDLE



Yarra View  
Dummy Plate  
YV-DUMMY  
PLATE

The Yarra View range is available in black, white, surfmist, and paperbark. Cylinders are not powdercoated

# Windsor Bi-Fold Door



The Windsor Bi-Folding door is the perfect solution for alfresco areas or Commercial Cafes. The Hardware is Marine Grade Stainless Steel to ensure long term reliable operation and has a 90kg weight limit. The hardware is fully adjustable and offers up to 10mm of adjustment in Height and Width. Windsor Bi-Fold Door integrates with the following systems: AluCOMM Hinge Door Panels (pg. 72), 10044-SG Center Glazed (pg. 8), 100mm Sub Framing (pg. 55), 10044-DG Center Glazed (pg. 10)

## PERFORMANCE

### WERS

#### U-Value

3.2-6.0

#### SHGC

0.21-0.57

#### TVW

0.18-0.59

### Performance Ratings:

#### N6 & C3 Non Exposed

#### Serviceability

Up to  
800 Pa

#### Ultimate Pressure

Up to  
1000 Pa

#### Water Penetration

Up to  
150 Pa

## FEATURES

- Captive wedge system available for simplified glazing
- Full range of hardware available in both stainless finish and black powdercoating.
- A range of accessories to suit including flush bolt locks, magnetic catches and hold open latches.

### DOUBLE GLAZED

24mm

### SINGLE GLAZED

5mm x 8mm

# Bi-Folding: Windsor Bi-Fold Door Profiles

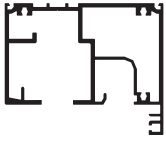

**Head**  
BF1  
Length: 6500/4500



**Frame**  
CA460  
Length: 6500



**Door Stop**  
BF3  
Length: 6500



**Open in Sill**  
BF10  
Length: 6500



**Open Out Sill**  
BF2  
Length: 6500



**Open out Sill w/Sub Sill**  
BF13  
Length: 6500

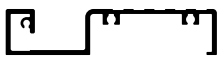

**Low Step Open In/Out Still**  
BF14  
Length: 6500



**Channel Sill**  
BF11  
Length: 6500

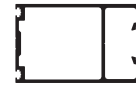

**S/G Door Stile**  
BF4  
Length: 6500/2800

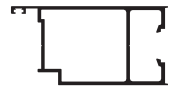

**S/G Lock Stile**  
BF5  
Length: 6500

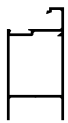

**S/G Rail**  
CD200  
Length: 6500



**Wide S/G Rail**  
CD201  
Length: 6500



**S/G Door Bead**  
CD202  
Length: 6500  
To suit CD200/  
CD201



**D/G Door Stile**  
BF8  
Length: 6500/2800

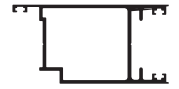

**D/G Lock Stile**  
BF7  
Length: 6500



**D/G Rail**  
DG904  
Length: 6500

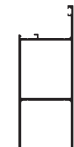

**Wide D/G Rail**  
DG905  
Length: 6500



**D/G Door Bead**  
CD318  
Length: 6500  
To suit DG904/  
DG905



**Deep Bi-Fold Stile**  
DG923  
Length: 6500/2800



**Deep Self Mating Stile**  
DG922  
Length: 6500



**Spigot**  
CD218  
To suit BF8/  
BF7/BF5/BF4

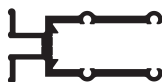

**Deep Stile Spigot**  
DS918  
To suit DG923/  
DG922



# Bi-Folding: Windsor Bi-Fold Door Hardware



**LH Pivot Set**  
93-101C



**Std. R/H Pivot Set**  
93-103C



**Std. L/H End Trolley 2 Wheel Set**  
93-291



**Offset R/H End Trolley 2 Wheel Set**  
93-293



**Offset Hinge Set**  
93-350



**Offset Meeting Carrier Set**  
93-299



**Std. Hinge Handle Set Open Out**  
93-320



**Std. Intermediate Carrier**  
93-400



**Std. Hinge Set**  
93-300



**Std. Inward Opening Handle**  
93-321



**Offset Hinge Handle Set**  
93-370



**Offset Inward Opening Handle**  
93-371



**Offset L/H 4 Wheel End Carrier Set**  
93-491



**Offset R/H 4 Wheel End Carrier Set**  
93-493



**Center Snubber Set**  
93-SN001



**Drilling Jig**  
93-DJ200



**Flush Bolt Guide**  
FB7



**Edge Lock Kit - Satin Chrome**  
Includes satin chrome Edge handles and rod kit  
XPL508-SC



**Edge Lock Kit - White**  
Includes white Edge handles and rod kit  
XPL508-WH



**Edge Lock Kit - Black**  
Includes black Edge handles and rod kit  
XPL508-SB

The Windsor Bi-Fold Door Hardware is available in both Stainless Steel and Black Powdercoat and is assembled especially to suit the Windsor Bi-Fold Door. The Windsor Bi-Fold Door is compatible with the Edge Hinge Door Lock (pg. 70).

# Bi-Folding: Windsor Bi-Fold Door Hardware



**Edge Twin-Bolt Lock Kit**  
Non-Locking / Black  
EDGE-KIT1



**Edge Twin-Bolt Lock Kit**  
Non-Locking / Chrome  
EDGE-KIT2



**Edge Twin-Bolt Lock Kit**  
Locking / Black  
EDGE-KIT3



**Edge Twin-Bolt Lock Kit**  
Locking / Chrome  
EDGE-KIT4



**Interlock Twin-Bolt Lock Kit**  
Non-Locking / Black  
INTERLOCK-KIT 1



**Interlock Twin-Bolt Lock Kit**  
Non-Locking / Chrome  
INTERLOCK-KIT 2



**Twin-Bolt 1m Extension Kit**  
P84017



**250mm Flush Bolt**  
Satin Chrome  
DN201-SC



**250mm Flush Bolt**  
Black  
DN201-BLK



**12.5mm Magnetic Bi-Fold Catch**  
MC101



**35mm Magnetic Bi-Fold Catch**  
MC100



**Hold Open Door Stop**  
DN227



**Weephole cover**  
WHC1239



**Bi-Fold Sill Gasket**  
BFG100  
To suit BF2



**Bi-Fold Sill Gasket**  
BFG102  
To suit BF10, BF13, BF14



**Stile Rubber**  
PX0648

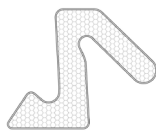

**Push in Bifold Aquamac Seal**  
AQ21



**Q-Lon Seal**  
QE248



**13mm Woolpile**  
PS13



**Co-Ex Sill Baffle**  
PX0040



**Captive Wedge**  
24mm  
PX0646



**Wedge**  
5mm  
PF0774-4



**Wedge**  
6mm  
PF0774-5



**Glazing Wedge**  
24mm  
PX0084

# Hinge Door



The Hinge Door is a commercial door that has been designed for both residential and a commercial applications; with a variety of sills ranging from open in and out and low thresholds available to meet Australian standards for Disability (Access to Premises - Buildings). It is a highly versatile system and can be matched with any of the AluCOMM framing systems. The Single Glazed Hinge Door profiles can be used in any of the AluCOMM framing systems.

---

## FEATURES

---

- Options for standard (73mm) and wide (114mm) stiles and rails.
- Newly developed deep pocket stile suite.
- Heavy duty stainless steel hinges.
- Weep hole covers available for subsills.
- Captive wedge system available.

### **SINGLE GLAZED**

5mm - 8mm

### **DOUBLE GLAZED**

24mm

# Hinge Doors: Single Glazed Profiles



**S/G Rail**  
CD200  
Length: 6500



**S/G Deep Rail**  
CD201  
Length: 6500



**45mm S/G Mid Rail**  
CD203  
Length: 6500



**123mm S/G Wide Mid Rail**  
CD204  
Length: 6500



**200mm Mid Rail**  
CD320  
Length: 6500



**S/G Bead**  
CD202  
Length: 6500



**S/G Lock Stile**  
CD213  
Length: 6500



**S/G Hinge Stile**  
CD214  
Length: 6500

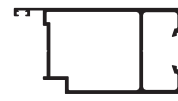

**S/G Lock Stile**  
BF5  
Length: 6500



**Plain Stile**  
CD220  
Length: 6500

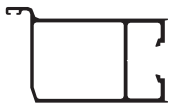

**Odd/Even Lock Stile**  
CD217  
Length: 6500



**S/G Wide Lock Stile**  
CD300  
Length: 6500



**S/G Wide Hinge Stile**  
CD301  
Length: 6500



**Meeting Stile Adapter**  
CA436  
Length: 4800



**2 Piece Plant On Door Stop**  
CA459  
Length: 6500

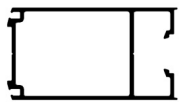

**S/G Rebate Face Stile**  
CA240  
Length: 6500



**Door Stop Pocket Filler**  
CA305  
Length: 6500



**Door Stop**  
CA427  
Length: 6500



**Spigot**  
CD218

# Hinge Doors: Double Glazed Profiles



**D/G Lock Stile**  
DG900  
Length: 6500



**D/G Hinge Stile**  
DG902  
Length: 6500

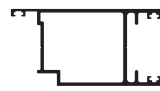

**D/G Lock Stile**  
BF7  
Length: 6500

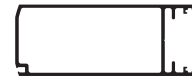

**D/G Wide Lock Stile**  
DG910  
Length: 6500



**D/G Wide Hinge Stile**  
DG906  
Length: 6500



**D/G Rail**  
DG904  
Length: 6500



**D/G Wide Rail**  
DG905  
Length: 6500

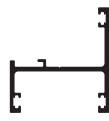

**45mm D/G Mid Rail**  
DG912  
Length: 6500



**100mm D/G Mid Rail**  
DG911  
Length: 6500



**Meeting Stile Adapter**  
CA436  
Length: 4800



**D/G Door Bead**  
CD318  
Length: 6500



**Spigot**  
CD218

The Double Glazed Hinge Door profiles can be used in any of the AluCOMM framing systems.

# Deep Pocket Double Glazed Profiles



**Deep Lock Stile**  
DG920  
Length: 6500



**Deep Hinge Stile**  
DG921  
Length: 6500



**Deep Self Mating Stile**  
DG922  
Length: 6500



**Deep Overlapping Stile**  
DG925  
Length: 6500



**Wide Deep Lock Stile**  
DG930  
Length: 6500



**Wide Deep Hinge Stile**  
DG931  
Length: 6500



**92mm Rebate Face Stile**  
DG940  
Length: 6500



**Deep Stile Spigot**  
DS918

The Deep Pocket Double Glazed Hinge Door profiles can be used in any of the AluCOMM framing systems and have been added to easily comply with AS1288

# Hinge Doors: Sills and Threshold Profiles



**Open in Sill**  
BF9  
Length: 6500

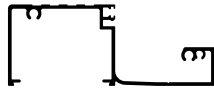

**Open Out Sill**  
CA429  
Length: 6500



**Open Out Threshold**  
CA428  
Length: 6500



**Open In Sill Gasket**  
Suit BF9  
BFG103



**Open Out Sill Gasket**  
Suit CA429  
BFG104



**Threshold**  
CA415  
Length: 6500



**100mm x 12.5mm Sloped Threshold**  
CA480  
Length: 6500



**150mm x 12.5mm Sloped Threshold**  
CA481  
Length: 6500



**100mm x 5mm Rounded Threshold**  
CA482  
Length: 6500

The Hinge Door Sills and Threshold can be used with any of the AluCOMM framing systems as long as the width matches. (e.g. 100mm or 150mm). The range of sloped and rounded Thresholds are fully compliant with AS1428.1 and NCC D12.5 & D3.3.

# Hinge Door: Edge Door Lock Kits



The Edge Hinge Door Lock is sold in kit form.

Kits include handles, a lock body, a lock body assembly, a cylinder with turn snib, strike plate to suit all applications, and twin-bolt rods.



**Satin Chrome Lock Kit**  
XPL508-SC

**Satin Chrome Lock Kit**  
XPL508-SC

**Pearl White Lock Kit**  
XPL508-PW

**Twin-Bolt 1m  
Extension Kit**  
P84017

# Yale Unity Entrance Lock



Yale Unity Entrance  
Lock  
Silver  
**YALE ES**

Yale Unity Entrance Lock has been designed with all necessary hardware to achieve AS1905.1-2015 fire certification integrated into the escutcheons. There's no additional hardware to install or modifications required. The lock can be controlled via your mobile phone.

# Hardware/Accessories

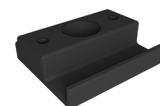

**Fast Fix Hinge  
Anodised**  
AH130CAN

**Fast Fix Hinge  
Black**  
AH130BLK

**Fast Fix Hinge  
White**  
AH130WH

**Flush Bolt Guide**  
FB7

**Flush Bolt Guide  
To suit BF9**  
FB3

# Hardware/Accessories

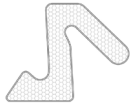

**Aquamac  
Push In Seal**  
AQ21



**13mm Woolpile**  
PS13



**Co-Ex Sill Baffle**  
PX0040



**Flush Bolt Ferrule**  
DN205



**250mm Flush Bolt  
Satin Chrome**  
DN201-SC



**250mm Flush Bolt  
Black**  
DN201-BLK



**45mm Door  
Stop Rubber**  
PF0812



**40mm Door  
Stop Rubber**  
PF0868



**Captive Wedge  
24mm**  
PX0646



**Glazing Wedge  
5mm**  
PF0774-4



**Glazing Wedge  
6mm**  
PF0774-5



**Glazing Wedge  
24mm**  
PX0084



# Pivot Door



The Commercial Pivot Door can add a real point of difference to your next project. Swiveling on a pivot instead of typical door hinges, this allows for a larger door panel and a larger range of rotation than a typical hinge door. We offer a range of stile options from standard (~70mm) to wide (~110mm).

## FEATURES

---

- Highly adaptable system.
- Dual seal door stiles for maximum performance.
- Wide Stile and rail options.
- A number of midrail size options.
- Beaded rails allow for on-site glazing.

Typically coupled to either the 10044-SG or 10044-DG Center Glazed systems, the Commercial Pivot Door can be coupled with all 100mm systems:

- 10044-SG Center Glazed System
- 10044-DG Center Glazed System
- 10055-DG Center Glazed System
- 10055-SG Front Glazed System
- 10055-DG Front Glazed System

### SINGLE GLAZED

5mm - 8mm

### DOUBLE GLAZED

24mm

# Pivot Door: Framing Profiles



**Jackson Closer  
Transom**  
CA425  
Length: 6500



**Jackson Closer  
Cover**  
CA426  
Length: 6500



**Frame**  
CA460  
Length: 6500



**Pocket Filler**  
CA409  
Length: 6500



**Door Stop**  
CA427  
Length: 6500



**100mm x 12.5mm  
Sloped Threshold**  
CA480  
Length: 6500



**100mm x 5mm  
Rounded Threshold**  
CA482  
Length: 6500



**Threshold**  
CA415  
Length: 6500

# Pivot Door: Single Glazed Profiles



**S/G Pivot Stile**  
CD216  
Length: 6500



**Wide S/G Pivot  
Stile**  
CD303  
Length: 6500



**S/G Rail**  
CD200  
Length: 6500



**S/G Deep Rail**  
CD201  
Length: 6500



**S/G Bead**  
CD202  
Length: 6500



**45mm S/G Mid Rail**  
CD203  
Length: 6500



**123mm Mid Rail**  
CD204  
Length: 6500



**200mm Mid Rail**  
CD320  
Length: 6500



**Spigot**  
CD218

# Pivot Door: Double Glazed Profiles

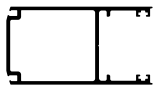

**Deep Pocket  
Pivot Stile**  
DG926  
Length: 6500



**D/G Top & Bot-  
tom Rail**  
DG904  
Length: 6500



**Wide D/G Rail**  
DG905  
Length: 6500

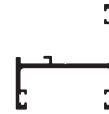

**45mm D/G  
Mid Rail**  
DG912  
Length: 6500

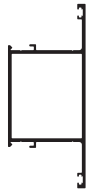

**100mm D/G  
Mid Rail**  
DG911  
Length: 6500



**D/G Door Bead**  
CD318  
Length: 6500



**Deep Stile  
Spigot**  
DS918

## Hardware/Accessories



**250mm Flush Bolt  
Satin Chrome**  
DN201-SC



**250mm Flush Bolt  
Black**  
DN201-BLK



**Flush Bolt Ferrule**  
DN205



**13mm Woolpile**  
PS13



**Door Stop  
Rubber**  
PF0812



**Captive Wedge  
24mm**  
PX0646



**Glazing Wedge  
5mm**  
PF0774-4



**Glazing Wedge  
6mm**  
PF0774-5



**Glazing Wedge  
24mm**  
PX0084

# Top Hung Sliding Door



Top Hung Sliding Doors are the perfect solution for any high traffic areas, with no bottom track required there is no trip hazard; this is a mandatory requirement for schools, hospitals and other commercial buildings. The Top Hung Profiles can be used with any of the AluCOMM framing systems to create a top hung sliding door.

## FEATURES

- 6.38mm-10.38mm Single Glazing.
- 24mm Double Glazing.
- 120Kg Weight per roller with height adjustment.
- Top Track end caps available.
- Wide Stile options available.
- Newly developed deep pocket stile options available.

### SINGLE GLAZED

5mm - 8mm

### DOUBLE GLAZED

24mm

# Top Hung Sliding Door: Framing Profiles

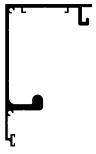

**Pelmet Track (Side mount)**  
CA478  
Length: 6500  
**To suit CR15**



**Pelmet Cover**  
CA479  
Length: 6500



**Top Track (Top mount)**  
CD327  
Length: 6500  
**To suit CR25**



**Door Floor Guide**  
CA435  
Length: 6500



**Single Track**  
CD322  
Length: 4000



**Sliding Guide /Receiver**  
CD328  
Length: 6500



**Guide Receiver /Cover**  
CD329  
Length: 6500  
**To suit CD328**

# Top Hung Sliding Door: Single Glazed Profiles

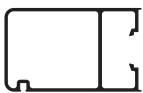

**S/G Sliding Stile**  
CD215  
Length: 6500



**Wide S/G Sliding Stile**  
CD302  
Length: 6500



**S/G Plain Stile**  
CD220  
Length: 6500



**200mm Mid Rail**  
CD320  
Length: 6500



**Wide S/G Rail**  
CD201  
Length: 6500



**S/G Bead**  
CD202  
Length: 6500



**45mm S/G Mid Rail**  
CD203  
Length: 6500

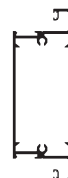

**123mm Mid Rail**  
CD204  
Length: 6500

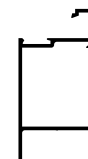

**S/G Rail**  
CD200  
Length: 6500



**Interlock**  
CD321  
Length: 6500

# Top Hung Sliding Door: Double Glazed Profiles



**D/G Sliding Stile**  
DG903  
Length: 6500

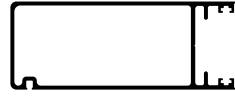

**Wide D/G Sliding Stile**  
DG908  
Length: 6500



**Deep Pocket Sliding Stile**  
DG924  
Length: 6500



**Wide Deep Pocket Sliding Stile**  
DG932  
Length: 6500



**D/G Rail**  
DG904  
Length: 6500

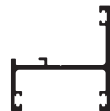

**45mm D/G Mid Rail**  
DG912  
Length: 6500



**100mm D/G Mid Rail**  
DG911  
Length: 6500

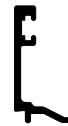

**D/G Door Bead**  
CD318  
Length: 6500



**Interlock**  
CD321  
Length: 6500

## Hardware/Accessories



Evolution Lock Kit  
Painted Flush Handles  
**EVOLUTION-KIT#5**



Evolution Lock Kit  
Black D-Handles  
**EVOLUTION-KIT#1**



Evolution Lock Kit  
Black Flush Handles  
**EVOLUTION-KIT#2**



Evolution Lock Kit  
S/S Flush Handles  
**EVOLUTION-KIT#3**



Evolution Lock Kit  
Painted D-Handles  
**EVOLUTION-KIT#4**



Umbra Flush Mount  
Sliding Door Lock  
**DS2500**



**150KG Top Hung Door Roller**  
(To suit Pelmet)  
CR15

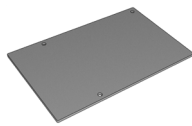

**Pelmet End Cap**  
To suit CA478  
ECD478  
To suit CA479 & CA478



**Spigot**  
CD218

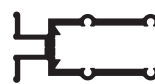

**Deep Stile Spigot**  
DS918

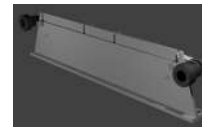

**Soft Close Top Hung Pelmet Sections**  
20-PSC160C-1692  
To suit CA479 & CA478



**Bottom Guide Roller**  
Suit Wide Rail  
20-PA50100-GU



**140KG Duel Wheel Carrier**  
(To suit CD327)  
CR25



**Captive Wedge**  
24mm  
PX0646



**Glazing Wedge**  
5mm  
PF0774-4



**Glazing Wedge**  
6mm  
PF0774-5



**Glazing Wedge**  
24mm  
PX0084

# Beads and Bases: Glazing Beads and Glazing Bases Profiles



**Glazing Base**  
CA010  
Length: 6500

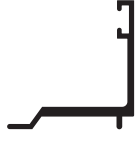

**Glazing Bead**  
CA703  
Length: 6500



**Glazing Channel**  
CA012  
Length: 6500



**25x25x3 Chan-  
nel C25253**  
Length: 6500



**25x40x3 Chan-  
nel C25403**  
Length: 6500



**32x32x3 Chan-  
nel C32323**  
Length: 6500



**40x25x3 Channel**  
C40253  
Length: 6500

# Gas Strut Window



The Gas Strut Window is the perfect choice for alfresco areas or kitchen servery windows because of its ability to effortlessly open in and out to a 90 degree angle. This window creates a large opening which allows it to maximise ventilation with minimal obstruction with a retractable flyscreen option. This system uses high performing gas struts and hinges which allow the window to open seamlessly.

## FEATURES

- 90 angle opening.
- Retractable flyscreen option.
- High performing gas struts and heavy duty face fixed hinges.
- Open out or flush sill option.
- Twin point locking through flush bolts.
- Available in full powdercoating range.
- Easy installation.

### SINGLE GLAZED

Up to 10.38mm

### DOUBLE GLAZED

24mm



# Gas Strut Window Profiles



**S/G Pivot Stile**  
CD216  
Length: 6500



**Deep Pocket Pivot Stile**  
DG926  
Length: 6500



**S/G Rail**  
CD200  
Length: 6500

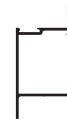

**D/G Rail**  
DG904  
Length: 6500



**S/G Door Bead**  
CD202  
Length: 6500



**D/G Door Bead**  
CD318  
Length: 6500

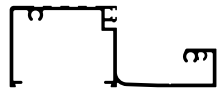

**Open Out Sill**  
CA429  
Length: 6500



**Frame**  
CA460  
Length: 6500



**2 Piece Plant On Door Stop**  
CA459  
Length: 6500



**Rail Cover End Cap**  
ECR38  
Length: 2400  
To suit CD200/  
DG904



**Pocket Filler**  
CA305  
Length: 6500  
To suit CA459

# Hardware/Accessories



**250mm Flush Bolt With Round Tip Satin Chrome**  
DN201-SC



**250mm Flush Bolt With Round Tip Black**  
DN201-BLK



**Flush Bolt Ferrule**  
DN205

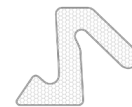

**Aquamac Push In Seal**  
AQ21



**Spigot**  
CD218  
To suit CD216

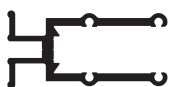

**Deep Stile Spigot**  
DS918  
To suit DG926

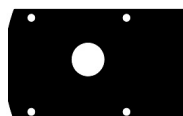

**Countersunk End Cap**  
ECD216  
To suit CD216



**Countersunk End Cap**  
ECD926  
To suit DG926



**685mm Gas Strut Kit**  
095389  
Includes 2 gas struts, 4 brackets



## Louvers, Privacy Screens and Battens

Add value to your home or office with our selection of privacy screens and louvers. Our range includes high-density commercial and residential options, which provide sunshade and privacy for your property.

The Privacy Screen system is a simple, low cost and easy to install system and is ideal for a range of applications. It is ideal for decorative fencing, window privacy screens as well as building facades. We offer a range of wood-grain finishing across our entire range of products - Louvre's and Privacy Screen are especially well suited and the results are stunning.

---

### FEATURES

---

- Louvers available in flat and elliptical blade shapes.
- A range of louver sizes from 60mm up to 175mm.
- Compatible with a range of applications including privacy screening and fencing, right up to full building facades.
- Available in powdercoat finishes as well as the stylish wood-grain finishing.

# Louvers, Privacy Screens and Battens

## Profiles



**100mm Frame**  
CA437  
6500mm

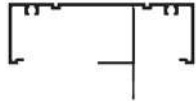

**100mm Frame With Reveal Leg**  
CAD163  
6500mm

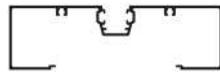

**150mm Frame**  
CA600  
6000mm



**Pocket Filler**  
CA409  
6500mm  
**To suit CA600**



**75mm Louvre Blade**  
CL108  
6500mm



**100mm Louvre Blade**  
CL102  
6500mm



**60mm Elliptical Blade**  
EB60  
6500mm

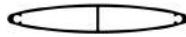

**80mm Elliptical Blade**  
EB80  
6500mm



**100mm Elliptical Blade**  
EB100  
6500mm



**150mm Elliptical Blade**  
EB150  
6500mm



**175mm Elliptical Blade**  
EB175  
6500mm

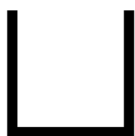

**Privacy Screen Channel**  
C202016  
6500mm

# Louvers, Privacy Screens and Battens



## Profiles

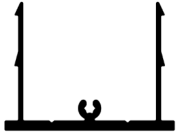

**50mm Batten Base**  
BTB  
6500mm  
To suit BT50/  
BT100/BT150/  
BT200/BT300

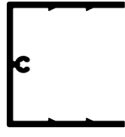

**50mm Batten**  
BT50  
6500mm

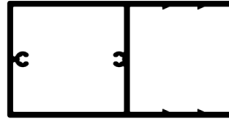

**100mm Batten**  
BT100  
6500mm  
4500mm



**150mm Batten**  
BT150  
6500mm  
4500mm

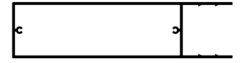

**200mm Batten**  
BT200  
6500mm  
4500mm

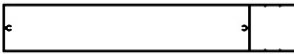

**300mm Batten**  
BT300  
6500mm  
4500mm

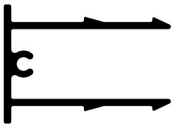

**26mm Back Adapter**  
BT26  
6500mm



**47mm Batten**  
BT47  
6500mm



**End Cap to suit 47mm Batten**  
ECB47  
Sold separately

## Hardware / Accessories

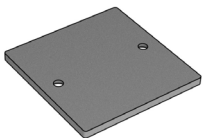

**Batten Cap**  
ECB-50  
To suit BT50

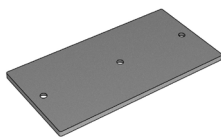

**Batten Cap**  
ECB-100  
To suit BT100

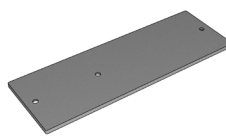

**Batten Cap**  
ECB-150  
To suit BT150

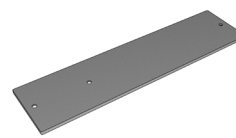

**Batten Cap**  
ECB-200  
To suit BT200



**Batten Cap**  
ECB-47  
To suit BT47



# Stealth Thermally Broken Roof Light Window

## Powder Coating

The Stealth Rooftop Window was previously available in mill finish and standard matt black powder coat finish. We now offer a range of powder coating finishes from our standard colour range. In addition to our extensive collection of coatings and colours, including the popular Colorbond® range. For colours outside the standard range, contact us to enquire about pricing and lead times.

### System Hardware

Gusset  
Code: **CS52**  
Length: 12.5mm x 1.42mm

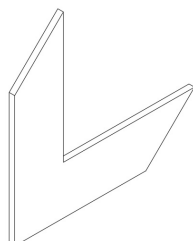

## Configurations

The Stealth Rooftop Window was previously available in set configurations. We now offer customized size configurations, to suit any application necessary.

### System Extrusion

Roof Window Frame  
Code: **J415001**  
Length: 4000mm

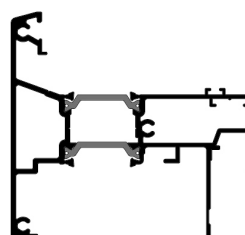

# Technical Guide

Featured in technical manual

Air Seal / Scriber Seal  
Low Density Foam Tape  
19 x 15mm  
Gasscorp Code GA8

Flashed Up stand in Roof  
by Roofing Contractor  
Flashed to MRM Code or  
Practice

Head Detail

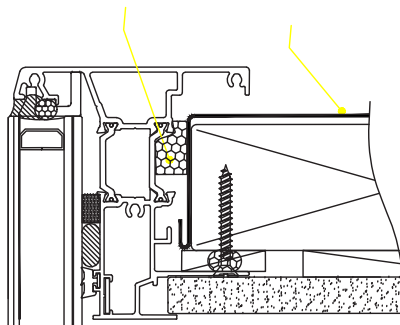

Jamb Detail

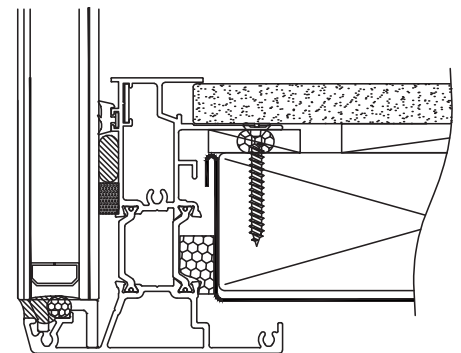

Foam or silicone Air seal  
Between Packers Around  
Perimeter

Sill Detail

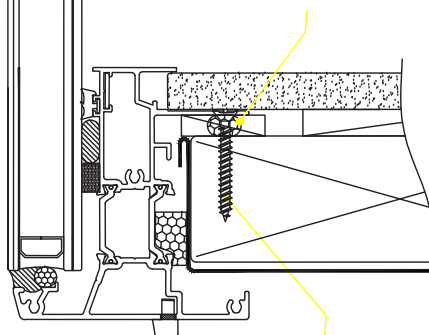

SS 8G x 1.5"  
CSK Wood screw  
150mm from corners  
and @400 cntrs elsewhere

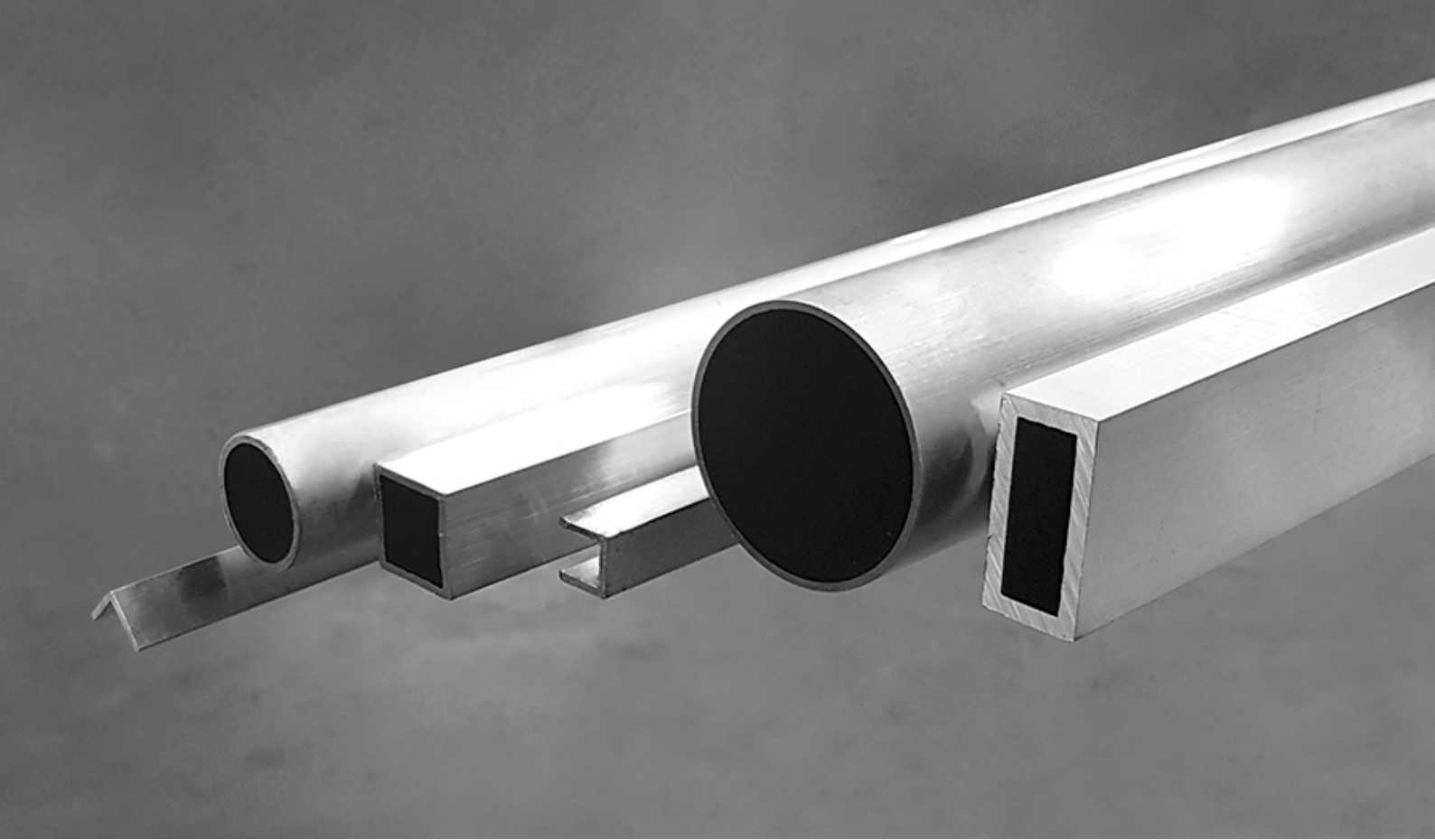

## Geometrics

Concept Architectural Systems offers a full range of standard geometric shapes:

- Powdercoated Angles
- Angles
- Channels
- Flat Bars
- Square Hollow Sections (SHS)
- Rectangular Hollow Sections (RHS)
- Sheets
- Treadplate

# Powder Coated Angles

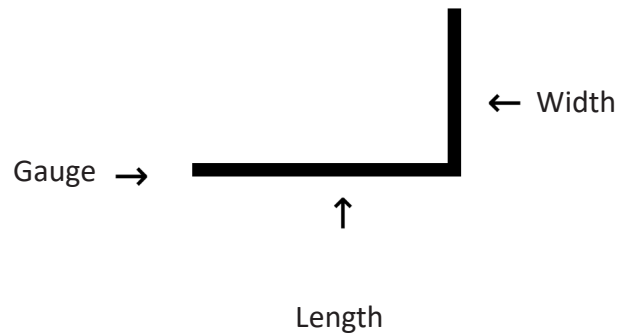

PRODUCT CODE	LENGTH	WIDTH	GAUGE	BAR LENGTH
A201216	20	12	1.6	6500
A252016	25	20	1.6	6500
A322016	32	20	1.6	6500
A402016	40	20	1.6	6500
A502516	50	25	1.6	6500
A702516	70	25	1.6	6500

## Available in our standard colour range

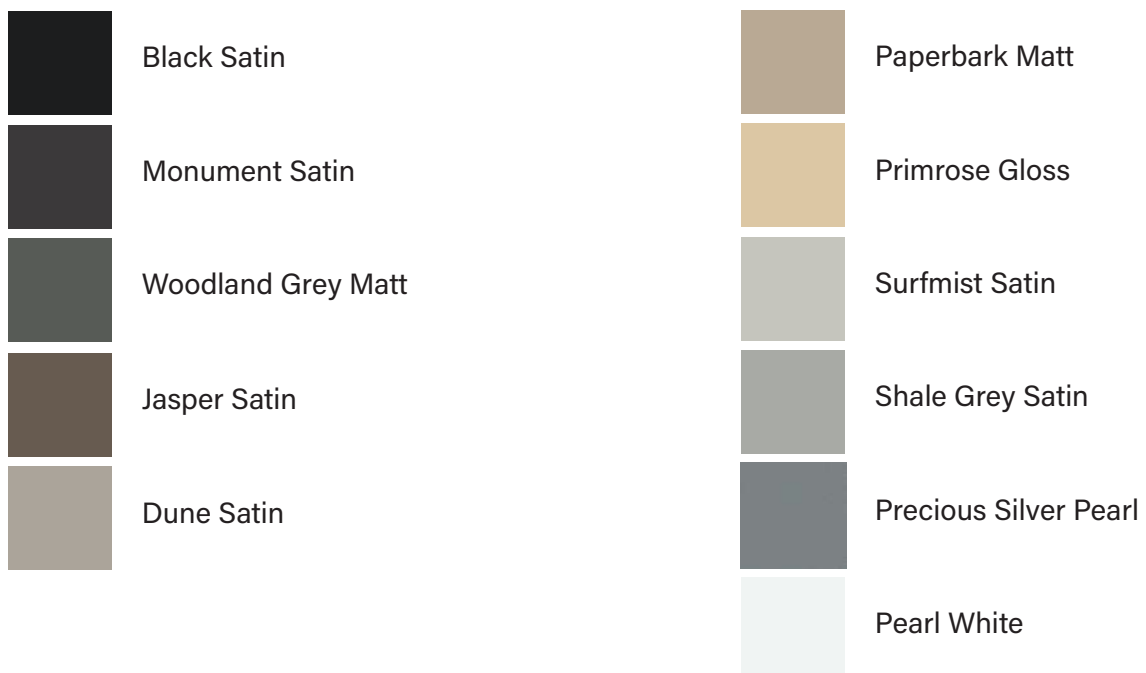



# Angles

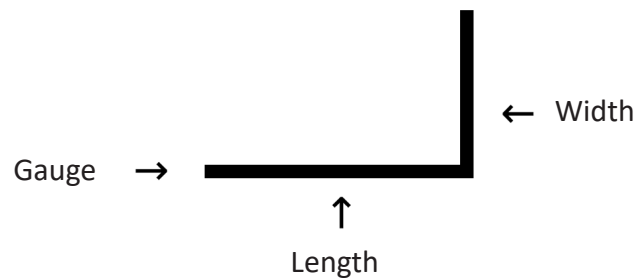

PRODUCT CODE	LENGTH	WIDTH	GAUGE	BAR LENGTH	MILL	PRE-TREATED	ANODISED
--------------	--------	-------	-------	------------	------	-------------	----------

A121216	12	12	1.6	6500	•		#
A201216	20	12	1.6	6500			•
A20123	20	12	3	6500	•		#
A202016	20	20	1.6	6500	•	•	#
A20203	20	20	3	6500	•		#
A251216	25	12	1.6	6500	•		#
A252016	25	20	1.6	6500			•
A25203	25	20	3	6500	•	•	#
A252516	25	25	1.6	6500	•	•	•
A25253	25	25	3	6500	•		•
A322016	32	20	1.6	6500			•
A32253	32	25	3	6500	•		#
A323216	32	32	1.6	6500	•	•	•
A32323	32	32	3	6500	•		•
A401216	40	12	1.6	6500	•		#
A402016	40	20	1.6	6500			•
A40203	40	20	3	6500	•		#
A40253	40	25	3	6500	•	•	#
A404016	40	40	1.6	6500	•		•
A40403	40	40	3	6500	•		•
A502516	50	25	1.6	6500			•
A50253	50	25	3	6500	•		#
A505016	50	50	1.6	6500	•	•	•
A50503	50	50	3	6500	•		•
A702516	70	25	1.6	6500			•
A704016	70	40	1.6	6500	•		
A76763	76	76	3	6500	•	•	
A904016	90	40	1.6	6500	•		
A100253	100	25	3	6500	•		
A100503	100	50	3	6500	•		
A100506	100	50	6	6500	#		
A125503	125	50	3	6500	#		
A2001008	200	100	8	6500	•	•	•

# Channels

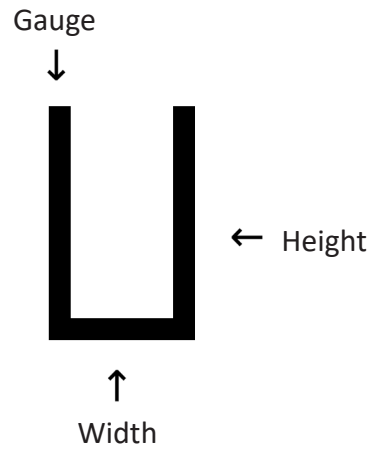

PRODUCT CODE	WIDTH	HEIGHT	GAUGE	BAR LENGTH	MILL	PRE-TREATED	ANODISED
C121216	12	12	1.6	6500	•		•
C161616	16	16	1.6	6500	•		•
C16163	16	16	3	6500	•		#
C201616	20	16	1.6	6500	•		#
C202016	20	20	1.6	6500	•		#
C20203	20	20	3	6500	•		#
C25123	25	12	3	6500	•		#
C252516	25	25	1.6	6500	•		#
C25253	25	25	3	6500	•		•
C25403	25	40	3	6500	•		•
C32253	32	25	3	6500	•		•
C32323	32	32	3	6500	•		•
C40203	40	20	3	6500	#		#
C40253	40	25	3	6500	•		#
C40403	40	40	3	6500	•		#
C50253	50	25	3	6500	•		#
C50503	50	50	3	6500	•		#
C100253	100	25	3	6500	•		

# Flat Bars



PRODUCT CODE	LENGTH	GAUGE	BAR LENGTH	MILL	PRE-TREATED	ANODISED
--------------	--------	-------	------------	------	-------------	----------

FB123	12	3	4000	•		#
FB163						
FB2016	20	1.6	3600	•		#
FB203	20	3	4000	•		#
FB204	20	4	4000	#		#
FB206	20	6	4000	#		#
FB2010	20	10	4000	#		#
FB2516	25	1.6	4000	•		#
FB256	25	6	4000	•		#
FB323	32	3	3600	•		#
FB3210	32	10	4000	#		#
FB403	40	3	4000	•		#
FB406	40	6	4000	•		#
FB503	50	3	4000	•		#
FB506	50	6	4000	•		#
FB5010	50	10	4000	•		#
FB603	60	3	3600	•		#
FB6012	60	12	4000	•		#
FB803	80	3	3600	•		#
FB806	80	6	4000	#		#
FB8010	80	10	4000	#		#

# Flat Bars



PRODUCT CODE	LENGTH	GAUGE	BAR LENGTH	MILL	PRE-TREATED	ANODISED
FB10016	100	1.6	3600	•		•
FB1003	100	3	4000	•		#
FB1006	100	6	4000	•		#
FB10010	100	10	4000	#		#
FB15016	150	1.6	3600	•		•

# Square Hollow Sections (SHS)

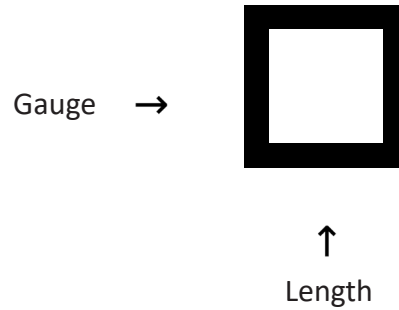

PRODUCT CODE	LENGTH	GAUGE	BAR LENGTH	MILL	PRE-TREATED	ANODISED
--------------	--------	-------	------------	------	-------------	----------

SHS1216	12.7	1.6	6500	#		
SHS2016	20	1.6	6500	•		
SHS203	20	3	6500	•		
SHS2516	25	1.6	6500	•		
SHS253	25	3	6500	•		
SHS3216	32	1.6	6500	•		
SHS323	32	3	6500	•		
SHS4016	40	1.6	6500	•		
SHS4025	40	2.5	6500	#		
SHS403	40	3	6500	•		
SHS5016	50	1.6	6500	•		
SHS5025	50	2.5	6500	#		
SHS503	50	3	6500	•		
SHS753	75	3	6500	•		
SHS1003	100	3	6500	•		

# Rectangular Hollow Sections (RHS)

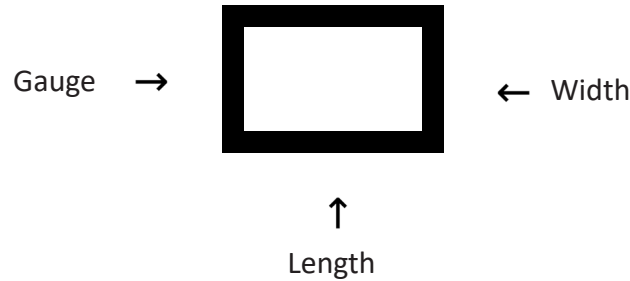

PRODUCT CODE	WIDTH	LENGTH	GAUGE	BAR LENGTH	MILL	PRE-TREATED	ANODISED
RHS382516	38	25	1.6	6500	•		
RHS40203	40	20	3	6500	•		
RHS402525	40	25	2.5	6500	#		
RHS501016	50	10	1.6	6500	#		
RHS50253	50	25	3	6500	•		
RHS50383	50	38	3	6500	•		
RHS60403	60	40	3	6500	#		
RHS762516	76	25	1.6	6500	•		
RHS76503	76	50	3	6500	#		
RHS80503	80	50	3	6500	•		
RHS100253	100	25	3	6500	•		
RHS1005016	100	50	1.6	6500	•		
RHS100503	100	50	3	6500	•		
RHS150503	150	50	3	6500	•		
RHS200503	200	50	3	6500	•		

# Sheets: Flat Alloy Sheets

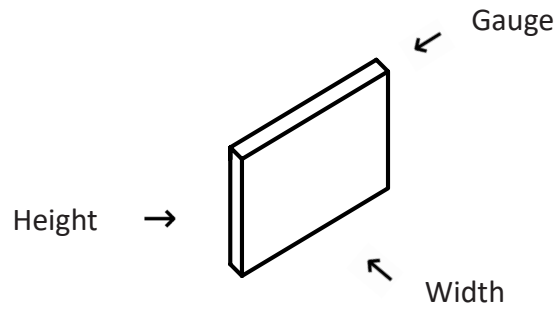

PRODUCT CODE	WIDTH	HEIGHT	GAUGE	MILL/POWDERCOAT	ANODISED
--------------	-------	--------	-------	-----------------	----------

CS1.612002400	2400	1200	1.6	•	•
CS1.612003000	3000	1200	1.6	•	•
CS1.612003600	3600	1200	1.6	•	•

# Treadplates: 5 Bar Treadplate Alloy

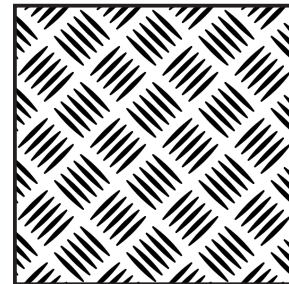
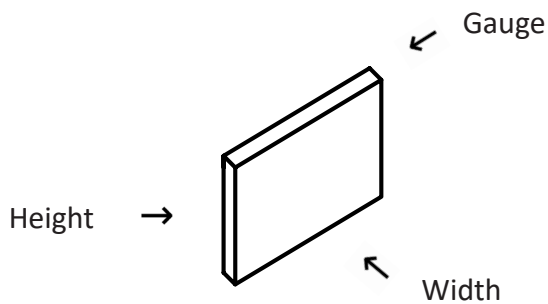

PRODUCT CODE	WIDTH	HEIGHT	GAUGE	MILL/POWDERCOAT	ANODISED
--------------	-------	--------	-------	-----------------	----------

TP1.512002400	2400	1200	1.5	•	•
---------------	------	------	-----	---	---



**Concept Aluminium Coatings Pty Ltd  
(ABN 97 007 214 897)  
CREDIT APPLICATION**

**BUSINESS DETAILS**

FULL TRADING NAME \_\_\_\_\_ (Applicant)  
(Is this Trading Name a Registered Business Name? YES  NO )

REGISTERED COMPANY NAME \_\_\_\_\_

ACN / ARBN \_\_\_\_\_ ABN \_\_\_\_\_

BUSINESS ADDRESS \_\_\_\_\_

STATE \_\_\_\_\_ POST CODE \_\_\_\_\_

BUSINESS PREMISES     Owned                       Leased                       Mortgaged                       Rented

NATURE OF BUSINESS \_\_\_\_\_ DATE BUSINESS ESTABLISHED \_\_\_\_\_

BUSINESS STRUCTURE     Sole Trader                       Private Company                       Public Company                       Trust  
    Partnership                       Co-operative                       Incorporated Association                       Government Authority

PAID UP CAPITAL OF COMPANY (if applicable) \$ \_\_\_\_\_ NO. OF EMPLOYEES \_\_\_\_\_

BANK \_\_\_\_\_ BRANCH \_\_\_\_\_ BSB NO. \_\_\_\_\_ ACCOUNT NO. \_\_\_\_\_

**TRADING HISTORY**

ANNUAL TURNOVER \$ \_\_\_\_\_ Is the most recent Balance Sheet available for review? YES  NO

Are assets of Business encumbered? YES  NO  AMOUNT \$ \_\_\_\_\_ TO WHOM \_\_\_\_\_

Are bad debts insured? YES  NO

**CONTACT DETAILS**

POSTAL ADDRESS (if different to above) \_\_\_\_\_

STATE \_\_\_\_\_ POST CODE \_\_\_\_\_

TELEPHONE \_\_\_\_\_ FAX \_\_\_\_\_ EMAIL \_\_\_\_\_

CONTACT PERSONS – Accounts \_\_\_\_\_ Telephone: \_\_\_\_\_

– Purchasing \_\_\_\_\_ Telephone: \_\_\_\_\_

**CREDIT REQUIRED**

ESTIMATED AMOUNT OF MONTHLY CREDIT REQUIRED \$ \_\_\_\_\_

**OWNERS' / DIRECTORS' DETAILS**

NAME \_\_\_\_\_ NAME \_\_\_\_\_

PRIVATE ADDRESS \_\_\_\_\_ PRIVATE ADDRESS \_\_\_\_\_

PHONE \_\_\_\_\_ PHONE \_\_\_\_\_

DATE OF BIRTH \_\_\_\_\_ DATE OF BIRTH \_\_\_\_\_

DRIVERS LICENCE NO \_\_\_\_\_ DRIVERS LICENCE NO \_\_\_\_\_

**INSOLVENCY**

Have any of the directors or proprietors been bankrupt or associated with an insolvent company? YES  NO

If Yes, NAME \_\_\_\_\_ YEAR OF BANKRUPTCY / INSOLVENCY \_\_\_\_\_

**TRADING REFERENCES (Please provide the names, addresses and phone numbers of four (4) current references.)**

NAME	ADDRESS	PHONE
1. _____	_____	(____) _____
2. _____	_____	(____) _____
3. _____	_____	(____) _____





**CORPORATE TRUSTEE**

Where the Applicant makes this application as a Trustee, it warrants and declares that it has the power and authority to make and execute this Credit Application and that all rights of indemnity which it now has or may have in the future or may otherwise have against the property of the Trust of which it is a Trustee or beneficiary or both, have not been modified or excluded as a result of any act, matter or document made or executed by it or as a result of any breach of fiduciary duty or in any other way. It warrants and declares further that it has not released and shall not release in the future and shall not cause or permit to be released, lost or diminished in any manner whatsoever, any such rights of indemnity.

NAME OF TRUST \_\_\_\_\_ DATE OF TRUST DEED \_\_\_\_\_  
NAME OF TRUSTEE \_\_\_\_\_ NAME OF SETTLOR \_\_\_\_\_  
ADDRESS OF TRUSTEE \_\_\_\_\_ BENEFICIARIES OF TRUST \_\_\_\_\_  
\_\_\_\_\_

**ACCEPTANCE**

The Applicant applies to Concept Aluminium Coatings Pty Ltd (ABN 97 007 214 897, ACM 887 214 857) ("Concept Aluminium Coatings") for credit. The Applicant acknowledges receipt of and accepts the present standard Terms and Conditions and acknowledges that the Terms and Conditions may be changed by Concept Aluminium Coatings from time to time.

Where the Applicant makes this application as a trustee, and details of the trust are not provided as above, the below signifies agree to indemnify Concept Aluminium Coatings against any loss of money due to Concept Aluminium Coatings by the Applicant, unless and until details of the trust are provided.

We warrant that I/we are authorized to sign this Credit Application on behalf of the Applicant.

SIGNATURE \_\_\_\_\_ SIGNATURE \_\_\_\_\_  
NAME (Block letters) \_\_\_\_\_ NAME (Block letters) \_\_\_\_\_  
POSITION \_\_\_\_\_ POSITION \_\_\_\_\_  
DATE \_\_\_\_\_ DATE \_\_\_\_\_

**PERSONAL GUARANTEE AND INDEMNITY**

We note that the leading Terms and Conditions have been provided to us by Concept Aluminium Coatings and that we have read and understood them. In consideration of Concept Aluminium Coatings supplying goods on credit to the Applicant:

I/we (and if more than one, jointly and severally) agree that if the Applicant at any time fails to pay any money due to Concept Aluminium Coatings or fails to perform or observe any term or condition of credit or sale to be performed by the Applicant, we will forthwith pay to Concept Aluminium Coatings all money due and payable by the Applicant (or any subsequent owner of the business name of the Applicant) to Concept Aluminium Coatings. No demand by Concept Aluminium Coatings for payment shall be necessary.

I/we further agree to indemnify Concept Aluminium Coatings against any loss of money due to Concept Aluminium Coatings by the Applicant under or relating to any sale by or credit granted by Concept Aluminium Coatings to the Applicant (or any subsequent owner of the business name of the Applicant) including expenses and legal costs associated with the collection of outstanding monies and including any loss suffered by Concept Aluminium Coatings as a result of the Applicant's failure to perform or observe any term or condition of credit or sale. I/we now charge in your interest in any real property registered in my/our names in favour of Concept Aluminium Coatings to secure this Guarantee and indemnity and authorize the lodgement of a caveat to support this charge.

I/we (and if more than one, jointly and severally) agree that this Guarantee and indemnity is a continuing Guarantee and indemnity and will not be invalidated, released or discharged by any event which would or might so invalidate, release or discharge the Guarantee and indemnity, including (but not limited to) the giving of time, the variation of the terms and conditions of credit or sale, the alteration of the composition of the Applicant, failure of a party to sign or the release of the Applicant or any co-guarantor. We understand this Guarantee and indemnity binds me/us personally.

SIGNATURE \_\_\_\_\_ SIGNATURE \_\_\_\_\_  
NAME (Block letters) \_\_\_\_\_ NAME (Block letters) \_\_\_\_\_  
WITNESS SIGNATURE \_\_\_\_\_ WITNESS SIGNATURE \_\_\_\_\_  
WITNESS NAME (Block letters) \_\_\_\_\_ WITNESS NAME (Block letters) \_\_\_\_\_  
DATE \_\_\_\_\_ DATE \_\_\_\_\_

**CREDIT CARD DETAILS (FOR C.O.D. CUSTOMERS ONLY)**

CARD TYPE: \_\_\_\_\_ (Visa, Mastercard, Bankcard)  
CARD NO: \_\_\_\_\_ EXPIRY DATE: \_\_\_\_\_ / \_\_\_\_\_  
CARDHOLDERS NAME: \_\_\_\_\_

I/we authorize and further notice to debit my credit card for amounts due arising from goods delivered on this account.

SIGNATURE: \_\_\_\_\_ DATE: \_\_\_\_\_

# TERMS AND CONDITIONS

Concept Aluminium Coatings Pty Ltd (ABN 97 007 214 897)

## 1 General

These terms and conditions ('Terms') plus any implied terms which cannot be excluded and (if applicable) any Supply Agreement are the whole agreement between applicant named in the Credit Application ('Customer or you/your') and Concept Aluminium Coatings Pty Ltd ABN 97 007 214 897 ('we/us/our'). No other contractual terms of a Customer (such as on a purchase order or otherwise) apply and, if provided, they don't constitute a counteroffer. If you accept delivery or supply of all or a portion of goods and/or services supplied under these Terms ('Goods'), you will be deemed to have accepted these Terms and they will apply to the exclusion of all others. We may vary these Terms by providing written notice to you (by email or conventional mail (or by posting the amended Terms on our website, if applicable)). We will not change any Terms for an existing order that has been accepted by us; the Terms that apply to the order are the Terms that applied at the time you placed the order.

## 2 Credit Terms

2.1 Payment is due on or prior to forty-five (45) days from the end of the month in which the invoice is issued unless we tell you in writing otherwise.

2.2 If we don't receive payment on the due date, we may charge interest (as liquidated damages) at the rate of two percent (2%) above the rate of interest fixed from time to time under Section 2 of the Penalty Interest Rates Act 1983 (Vic) and suspend or discontinue supply of the Goods to you and/or cancel your account with us.

2.3 We may revoke our express or implied approval for giving you credit at any time.

2.4 We can set-off against any money owing to you amounts owed to us by you on any account whatsoever.

2.5 Any payments received from you on overdue accounts will be applied first to satisfy interest which may have accrued, second to reasonable expenses and legal costs, and then to principal.

2.6 You are liable for all reasonable expenses (including contingent expenses such as debt collection commission) and legal costs (on a full indemnity basis) incurred by us for enforcement of obligations and recovery of monies due from you to us.

2.7 All sums outstanding become immediately due and payable by you to us if you make default in paying any sums due to us, you become bankrupt, or commit any act of bankruptcy, compound with your creditors, have judgment entered against you in any court or, being a company, have a provisional liquidator, liquidator, receiver, receiver manager or administrator appointed, notwithstanding the provisions of any other clause in these Terms.

## 3 Quotations and Pricing

3.1 You may from time to time place written orders with us setting out the requirements of the order including the delivery address. You may include as part of the order a requested delivery date. However, we do not guarantee that we will deliver by the date requested.

3.2 Following receipt of the order, within 14 days we will confirm the order.

3.3 Prices charged will be according to a current quotation or determined by us by reference to our standard prices in effect at the date of delivery (whether notified to you or not and regardless of any prices contained in the order). We will use our best endeavours to notify you of price changes but bear no liability in respect of this.

3.4 Any quotation shall not constitute an offer and will remain valid only for 30 days from the date of the quotation. We reserve the right to vary the quotation due to circumstances beyond our control that may affect our ability to complete or perform the terms of the quotation.

Documents requiring signature may be signed in electronic form and are binding from the time a person affixes a signature on your behalf.

3.6 You shall pay any variations in the invoice or contract price as a consequence of currency fluctuations.

3.7 This agreement shall not be affected by any impositions or alterations of customs duties or by decisions of the Customs Department with regard to either classification or value of duty or landing charges. Any such impositions shall be payable by you.

3.8 If we have not specified the price to be charged to the Customer at the time when the Customer places its order, the price charged to the Customer shall be the price ruling as at the date of delivery. The Customer acknowledges that our prices are subject to alteration from time to time.

## 4 Delivery and Supply

4.1 We shall not be liable for delay in delivery/supply. If we quote a time for delivery or supply, it's an estimate only. We can stop supply/delivery if you fail to comply with the Terms.

4.2 We may refuse to supply any order in our absolute discretion (except where these Terms constitute a small business contract for the purposes of the Australian Consumer Law ('Small Business Contract') and may make acceptance of an order conditional upon receiving a satisfactory credit assessment of the Customer.

4.3 If you tell us to deliver the Goods over different times or to different addresses from those specified in the Credit Application, then you: (1) shall be liable for any additional cost, charge and expense incurred by us in complying with your direction; (2) shall pay for the whole of the invoiced value of the Goods pursuant notwithstanding the staggered deliveries; and (3) such action shall be deemed to be delivery to you.

4.4 You are deemed to accept delivery of the Goods where it is either delivered to your premises or when we notify you that the Goods are available for collection.

4.5 If you are unable or fail to accept delivery of the Goods, we may deliver it to a place of storage nominated by you and, failing such nomination, to a place determined by us. Such action shall be deemed to be delivery to you. You shall be liable for all cost, charge and expense incurred by us on account of storage, detention, double cartage/delivery or similar causes.

4.6 Subject to Clause 4.1, you agree that you will be obliged to and shall pay for the Goods on the due date notwithstanding that delivery is made after the agreed delivery date, and notwithstanding that the Goods may not yet be delivered.

## 5 Property

5.1 Until full payment has been made for all Goods, and for any other sums in any way outstanding from you from time to time:

5.1.1 Title to the Goods shall not pass to you and you shall hold the Goods as bailee for us (returning the same to us on request). The Goods shall nevertheless be at your risk from the time of delivery/supply and you must insure the Goods from the time of delivery/supply.

5.1.2 You are only authorised to sell the Goods (or any portion of them) to third parties as our fiduciary agent provided that there shall be no right to bind us to any liability to such third party by contract or otherwise.

All payments (direct or indirect) received from such third parties by you for the Goods (or any portion of them) shall be held on trust for us pursuant to the fiduciary relationship, except where clause 6.6 applies.

5.1.3 If you incorporate or transform the Goods (or any portion of them) into any other goods or products produced by you (or a third party), then you must hold a proportion of any payment ('relevant proportion') received by you for such goods or products on trust for us. You expressly acknowledge that the relevant proportion shall be equal to the dollar value of the Goods incorporated or transformed.

5.1.4 We are irrevocably authorised to enter any premises where the Goods are kept, and to use your name and to act on your behalf, if necessary, to recover possession of the Goods without liability for trespass or any resulting damage.

## TERMS AND CONDITIONS

5.2 In addition to any lien to which we may, by statute or otherwise, be entitled, we shall in the event of your insolvency, bankruptcy or winding up, be entitled to a general lien over all property or goods belonging to you in our possession (although all or some of such property or goods may have been paid) for the unpaid price of any Goods sold or delivered to you under this or any other contract.

### 6 Personal Property Security Interest

6.1 You grant a security interest in the Goods and the proceeds (as defined in the Personal Property Securities Act 2009 ('PPSA')) to secure the obligation to pay the purchase price of the goods and other of your obligations to us under this agreement (together the "Indebtedness"). You warrant that the Goods are not purchased for personal, domestic or household purposes.

6.2 Where the Goods and/or proceeds are not readily identifiable and/or traceable or their recoverable value is insufficient to pay the Indebtedness, the security interest shall also extend to all the Goods present and after acquired by the Customer, of which the Goods form part, to the extent required to secure the Indebtedness.

6.3 You waive any right to receive notice in relation to any registration or amendment to a registration on the Personal Property Security Register ('PPSR'). At your own expense, you will provide all reasonable assistance and relevant information to enable us to register on the PPSR and generally to obtain, maintain, register and enforce the security interests created by this agreement.

6.4 Any payments received from you shall be deemed to be made and applied by us in the following order (unless we otherwise determine): (1) to any obligation owed by you which is unsecured, in the order in which the obligations were incurred; (2) to any obligations that are secured, but not by a purchase money security interest ('PMSI'), in the order in which those obligations were incurred (3) to obligations that are secured by a PMSI, in the order in which those obligations were incurred.

6.5 Until you have paid all money owing to us, you must at all times ensure that (1) all Goods, while in your possession, can be readily identified and distinguished, and/or (2) all proceeds (in whatever form) that you receive from the sale of any of the Goods are readily identifiable and traceable.

6.6 Subject to clause 5.1.2, if the Goods are held by you as inventory (as defined in the PPSA), then you may sell or lease the Goods in the ordinary course of business. Otherwise until you have paid all money owing to us you must not sell or grant a security interest in the Goods without our written consent.

6.7 To the extent permissible by law, you agree that the following provisions of the PPSA will not apply and you will have no rights under them: Section 95 (to the extent that it requires the secured party to give notices to the grantor); section 96; section 118 (to the extent that it allows a secured party to give notice to the grantor); section 121(4); section 125; section 130; section 132(3)(d); section 132(4); section 135; section 142; section 143.

6.8 Section 115(7) of the PPSA allows for the contracting out of provision of the PPS Act, the following provisions of the PPS Act will not apply and the Customer will not have any rights under them: section 127; section 129(2),(3); section 130(1); section 132; section 134(2); section 135; section 136(3), (4) and (5) and section 137.

6.9 Unless otherwise agreed and to the extent permitted by the PPSA, the parties agree not to disclose any information of a kind referred to in section 275(1) of the PPSA to an interested person or any other person. You waive any right you may have, or but for this clause may have had, under section 275(7)(c) of the PPSA to authorise the disclosure of the above information.

## Concept Aluminium Coatings Pty Ltd (ABN 97 007 214 897)

### 7 Availability of Stock

Any order that cannot be fulfilled on its receipt will automatically be back ordered and processed when stock becomes available unless it is your stated standard policy not to accept back orders or you specifically mark your order, "Do Not Back Order". Deliveries at any time are subject to the availability of stock and we will not be liable for any charges due to product unavailability.

### 8 Restrictions

You acknowledge and accept that we sell our goods only through persons who have been authorised by us to sell specific product categories at specific locations and who comply with our Terms and Conditions. Subject to the provisions of the Competition and Consumer Act 2010: (1) you are prohibited from selling Goods on the international market without our express written consent; and (2) does not grant to you the exclusive right to sell our Goods. We reserve the right to authorise and/or supply additional retailers in any market area that it deems necessary to adequately cover the market.

### 9 Freight

Subject to Clause 3.5 and unless otherwise agreed, we will ship by the least expensive route and carrier to all points. If the purchaser chooses a route with a higher charge than the route of our choice for shipment, we will charge the difference to you.

#### 10 Returns, Cancellations and Claims

10.1 You must not return any Goods to us without obtaining our prior authorisation. No returns will be accepted unless a copy of the relevant invoice is enclosed with the returned Goods. A list of the Goods returned including product descriptions, quantity, date of return and your name and address must also be enclosed. Freight charges must be paid by you. You shall be responsible for all damage incurred during return shipment. We will issue a credit note only after Goods returned are either collected by our authorised representative or agent or returned to us as set out above. You must not deduct the amount of any anticipated credit from any payment due to us but must await receipt of a credit note.

10.2 All goods returned must be of merchantable and reasonable quality.

10.3 If we accept the return of any Goods that have been ordered, we may charge you ten per cent (10%) of the invoice price as a handling fee with freight costs and risk remaining your responsibility.

10.4 We will not accept cancellations or partial cancellation of an order unless we have first consented in writing to such cancellation or partial cancellation and unless a cancellation charge has been paid which, as determined by us, will indemnify us against direct all loss.

10.5 All complaints, claims, or notification of lost Goods, incomplete Goods, Goods damaged in transit or Goods that do not comply with your purchase order must be submitted to us in writing within fourteen (14) days of delivery. Otherwise, you are deemed to have accepted the Goods and shall not refuse to pay for the Goods on the basis that they were lost, incomplete, damaged in transit, or do not comply with your purchase order.

#### 11 Privacy Act 1988 ('Privacy Act')

11.1 To enable us to assess your application for credit, you authorise us: (1) to obtain from a credit reporting agency/body a consumer or commercial credit report containing personal information about you and any guarantors; and (2) to obtain a report from a credit reporting agency/body and other information in relation to your commercial credit activities, and (3) to give to a credit reporting agency/body information including identity particulars and application details.

11.2 You authorise us to give to and obtain from any credit provider named in the accompanying Credit Application and credit providers that may be named in a credit report issued by a credit reporting agency/body information about your credit arrangements. You understand that this information can include any information about your credit worthiness.

11.3 You understand that information can be used for the purposes of assessing your application for credit, assisting you to avoid defaulting on your credit obligations, assessing your credit worthiness and notifying other credit providers and credit reporting agencies of a default by you under these Terms.

## **12 Notification**

You must notify us in writing within seven (7) days of: (1) Any alteration of your name or ownership; (2) the issue of any legal proceedings against you; (3) the appointment of any provisional liquidator, liquidator, receiver, receiver manager or administrator to you; and (4) Any change in the ownership of your business name. You agree that you shall be liable to us for all Goods supplied to the new owner by us until notice of any such change is received.

## **13 Warranties**

13.1 No warranties except those implied and that by law cannot be excluded are given by us in respect of Goods supplied. Where it is lawful to do so, our liability for a breach of a condition or warranty is limited to the repair or replacement of the Goods, the supply of equivalent Goods, the payment of the cost of repairing or replacing the Goods or acquiring equivalent Goods, as determined by us.

13.2 No warranties except those implied and that by law cannot be excluded are given by us in respect of Goods supplied. If you are a consumer for the purposes of the Australian Consumer Law ('Consumer'), our liability for a breach of a condition or warranty is limited to:

13.2.1 The repair of the Good(s) or the cost of repairing the Good(s) if we determine that there has been a minor fault; or

13.2.2 If it is not possible to repair the Good(s), or if we determine that there has been a major fault (which may include multiple minor faults), the replacement of the Good(s) or refund of the price paid for the Good(s), as determined by you; or

13.2.3 If a minor fault prevents the Good(s) from being used for their intended purpose within 30 days after purchase, the replacement of the Good(s) or refund of the price paid for the Good(s) as determined by you.

13.3 If the Goods are returned in accordance with this clause 13, you are responsible for returning the Goods to our premises. If the Goods are confirmed to have a minor fault or major fault, you may recover reasonable postage or transportation costs from us and no handling fee is payable by you.

13.4 You acknowledge and warrant that you have relied on your own skill and judgment or, alternatively, on the skill and judgment of tradesmen and professional advisers retained by you to provide advice and assistance on the suitability of the Goods for specific purposes and procedures and, in this respect, you shall indemnify us from and against any suit, claim, demand or compensation which, but for these Terms, you may have had against us, except if you are a Consumer or these Terms are deemed to be a Small Business Contract.

13.5 You warrant to us that you are purchasing Goods as the principal and not as an agent.

## **14 Termination**

We may terminate this Agreement if you do any of the following, which is not remedied within 7 days of written notice given by us:

14.1 Committing a material breach of these Terms which includes but is not limited to the failure to make payment for our Goods by the due date;

14.2 Becoming bankrupt, committing an act of bankruptcy or having judgment entered against you in any court.

## **15 Intellectual Property**

15.1 All intellectual property rights (including all rights resulting from intellectual activity and includes copyright, inventions, patent rights, registered and unregistered trademarks, design rights, circuit layouts and all rights and interests of a like nature, including but not limited to methods and techniques, together with any documentation relating to such our rights and interests), including those developed during the supply of the Goods remain our sole property, including in the capacity of licensee, at all times.

15.2 If we terminate this agreement, we may immediately reclaim any material incorporating our intellectual property and you grant us an irrevocable licence to enter upon your premises to reclaim such material without incurring liability to you or any other person.

## **16 Indemnity**

You indemnify us, and will keep us indemnified, against any claim, loss or expense or liability, including loss of profits, suffered by us, in respect of a breach of the Terms by you and any negligent act or omission by you or any of your consultants, employees, agents or contractors.

## **17 Force Majeure**

We shall be released from our obligations in the event of national emergency, war, prohibitive governmental regulation or if any other cause beyond the control of the parties renders provision of the Goods impossible, where all money due to us shall be paid immediately and, unless prohibited by law, we may elect to terminate the Agreement.

## **18 Equitable Charge**

You as beneficial owner and/or registered proprietor now charge in favour of us all of your estate and interest in any real property (including but not limited to any applicable land owned by you and, if applicable, land described as the street address in the Credit Application if applicable) ('Land') to secure payment of accounts rendered by us to you for the delivery and/or supply of the Goods including interest payable on these accounts and costs (including legal costs on a full indemnity basis) incurred by us and including the costs to prepare and lodge a caveat against the Land and to remove the caveat.

## **19 Variation**

19.1 We may vary these Terms by providing written notice to you (by email, conventional mail or by posting the amended terms on our website).

19.2 If you are a Consumer, or this agreement is deemed to be a Small Business Contract, and you do not deem the variation acceptable, you may elect not to proceed with the purchase of the Goods ordered before the date of the variation but which are intended to be subject to the variation.

19.3 If you are not a Consumer and this agreement is not deemed to be a Small Business Contract, you agree that the variation applies from the date of receiving notice of the varied Terms.

## **20 Failure to Act**

Our failure to enforce or insist upon the timely performance of any term, condition, covenant or provision in these Terms, or our failure to exercise any right or remedy available under these Terms or at law, or our failure to insist upon timely payment of monies when due or to demand payment of any charges or fees which accrue or any extension of creditor forbearance under these Terms shall not constitute a waiver of any subsequent default or a waiver of our right to demand timely payment of future obligations or strict compliance with the Terms.

## **21 Legal Construction**

21.1 These Terms shall be governed by and interpreted according to the laws of Victoria and the parties consent and submit to the jurisdiction of the Courts of Victoria.

21.2 Notwithstanding that any provision of the Terms may prove to be illegal or unenforceable pursuant to any statute or rule of law or for any other reason that provision is deemed omitted without affecting the legality of the remaining provisions and the remaining provisions of the Terms shall continue in full force and effect.



17 Broadfield Rd Broadmeadows VIC 3047

03 9357 2888

[www.conceptaluminium.com.au](http://www.conceptaluminium.com.au)

